

OVER 2035 LIVES SAVED



RAMPART
WE EQUIP YOUR MISSION

**CANADA'S LEADING SUPPLIER
OF OPERATIONAL EQUIPMENT**

WE EQUIP YOUR MISSION

Rampart is Canada's leading single source provider of **operational equipment**. We offer access to the largest selection of products and brands, world-class subject matter experts, and industry-leading customer service.



EQUIPMENT SOLUTIONS

Our experts are committed to serving the end-user with the world's best products.

If you're unsure of what you need, our experts work with you to find the right solution.



CUSTOMER SERVICE

Our top priority is to provide the highest level of customer service.

Our team is dedicated to providing on time, on budget, on target solutions.



SUBJECT MATTER EXPERTISE

We have subject matter experts who can help and assist every step of the way.

From initial request, to post-contract delivery, warranty, repair and anything else that might come up.

WHO WE SERVE

- ✓ **Military** *All branches*
- ✓ **Police** *Federal, provincial and municipal*
- ✓ **Corrections**
- ✓ **Wildlife & Conservation**
- ✓ **Armed Government Services**
- ✓ **Public Safety & Security**
- ✓ **Wildland Fire**



PERFECTION

Rampart is proud to be the exclusive provider of GLOCK firearms to Military and Law Enforcement in Canada.

**WE CAN MEET EVEN THE
MOST CHALLENGING MISSION
REQUIREMENTS.**

BRING US YOURS.

CONTACT US TODAY

Speak to a specialist now: **1-855-729-0446**

Email us: **support@rampartcorp.com**

Online: **www.rampartcorp.com**

RAMPART RANGE DAY

CANADA'S PREMIERE RANGE DAY AND EXPO
FOR MILITARY AND LAW ENFORCEMENT

GET HANDS-ON WITH THE LATEST TACTICAL
EQUIPMENT

- ✓ OVER 70 VENDORS
- ✓ LIVE-FIRE RANGES
- ✓ DEMONSTRATIONS & TRAINING
- ✓ COFFEE & LUNCH PROVIDED

RSVP NOW
RAMPARTCORP.COM/RANGEDAY

NOTE: ATTENDEE ACCESS TO RANGE DAY IS LIMITED
TO ACTIVE SERVING MILITARY, LAW ENFORCEMENT,
& CORRECTIONS PERSONNEL



HOSTED BY
RAMPART
WE EQUIP YOUR MISSION

RAMPART



SHIELD

SAVINGS FOR THOSE IN UNIFORM

EXCLUSIVE ACCESS AND SAVINGS ON FIREARMS,
GEAR AND APPARELL FOR CURRENT OR FORMER
UNIFORMED PROFESSIONALS.



MILITARY



LAW ENFORCEMENT
& CORRECTIONS



GOVERNMENT



EMS & FIRE

SAVE ON SOME OF OUR TOP BRANDS



PERFECTION

Aimpoint **ASP**

CARINTHIA

...AND MANY MORE

SIGNUP FOR FREE
RAMPARTCORP.COM/SHIELD

TOGETHER, W



38 LIVES SAVED IN 2018

The Safariland Group SAVES CLUB® honors those who, during the line of duty, experienced a life-threatening incident in which their Safariland® armor or gear contributed to saving their lives.

WILL GRAEBER
SAVE 2001

BENJAMIN GIESELMAN
SAVE 2002

KENT MAYFIELD
SAVE 2003

CONFIDENTIAL
SAVE 2004

JOHN ROTONDI
SAVE 2005

JEFF COOK
SAVE 2006

ARNOLD MENCHACA
SAVE 2007

RICHARD GONZALES
SAVE 2008

DAVID BARAJAS
SAVE 2009

UVALDO AVILEZ
SAVE 2010

SAVE LIVES®

STEVEN PRICE
SAVE 2011

WARREN LILLIE
SAVE 2021

MELVIN DIXON
SAVE 2031

JOE CASTELLANO
SAVE 2012

DANIEL DERMYER
SAVE 2022

STEVE RAPIER
SAVE 2032

JOAQUIN GALVAN
SAVE 2013

FRANK O'DONNELL
SAVE 2023

BRYAN SPIELER
SAVE 2033

JASON DUCRE'
SAVE 2014

PATRICK SHRODES
SAVE 2024

KATHERINE WEISS
SAVE 2034

TORREY JOHNSON
SAVE 2015

KAITLIN EDWARDS
SAVE 2025

GLEN LUCAS
SAVE 2035

JUSTIN QUINNELLY
SAVE 2016

JAMES BUDDY BROWN
SAVE 2026

SETH KELLY
SAVE 2036

NICK KEHOE
SAVE 2017

MICHAEL ALFORD
SAVE 2027

ERNEST GREENLEAF
DG SAVE

KYLE LUBER
SAVE 2018

ADAM HICKS
SAVE 2028

LUIS DUARTE
SAVE 2037

MANUEL SANTOS
SAVE 2019

GABRIEL POPE
SAVE 2029

TONY ALVES
SAVE 2020

MARC CONNORS
SAVE 2030

TABLE OF CONTENTS

CONCEALABLE ARMOR	4
TACTICAL ARMOR	16
COMMUNICATIONS	44
DUTY GEAR	56
PROTECTIVE GEAR	138
FIREARMS ACCESSORIES	152
LESS LETHAL	164
PERFORMANCE APPAREL	212
SURVIVABILITY SYSTEMS	214
FORENSICS	218
ARMOR SYSTEMS	220
TRAINING GROUP	224





PRESIDENT'S LETTER

Over the past 55 years, The Safariland Group has been developing innovative protective gear and equipment that has contributed to saving over 2035 lives. We honor those who have experienced a life-threatening incident, and welcome them to the SAVES CLUB®.

We are incredibly proud of these heroes. These officers – who were able to go home to their families and communities afterwards – represent all that we do at Safariland. Our mission is “Together, We Save Lives” and our goal is to provide the most technologically advanced protective equipment to those who put themselves on the line, day in and day out.

Looking ahead, we recognize The Safariland Group is in a unique position with our many brands to forge new paths by integrating performance products and solutions to improve officer safety. Through integration, innovation and the constant pursuit of perfection, we intend to empower, equip and protect every law enforcement officer with the best protective products on the planet.

Sincerely,

SCOTT O'BRIEN
PRESIDENT

CONCEAL



ABLE ARMOR



SAFARILAND[®]
ARMOR



Safariland[®] Body Armor is purpose-built for protection, comfort and fit for the demanding way an officer moves and works. Designed for maximum coverage and maneuverability, each ballistic panel and carrier features technologically advanced materials and design elements. Best-in-class ballistic performance optimizes coverage, weight, thinness and flexibility throughout the entire line.

Every Layer is Built to Perform

Each ballistic panel is engineered to provide unparalleled protective performance, while ergonomically designed to follow the body's natural shape and movement for flexibility and enhanced range of motion. With maximum coverage, stopping power, and all-day comfort.

DEFIES THE ELEMENTS

Heat-sealed TPU cover helps prevent bullet penetration and keeps the panel dry even in extreme conditions. Soft nylon shell increases comfort and durability. (Excludes Hardwire)

THE RIGHT FIT

Specific male and female panels feature a contoured biomorphic design with perimeter stitching to enhance comfort and stopping power.

DISPERSED ENERGY

Ballistic subsets made of high-performance ballistic materials disperses a bullet's impact yet is thin, light and flexible.

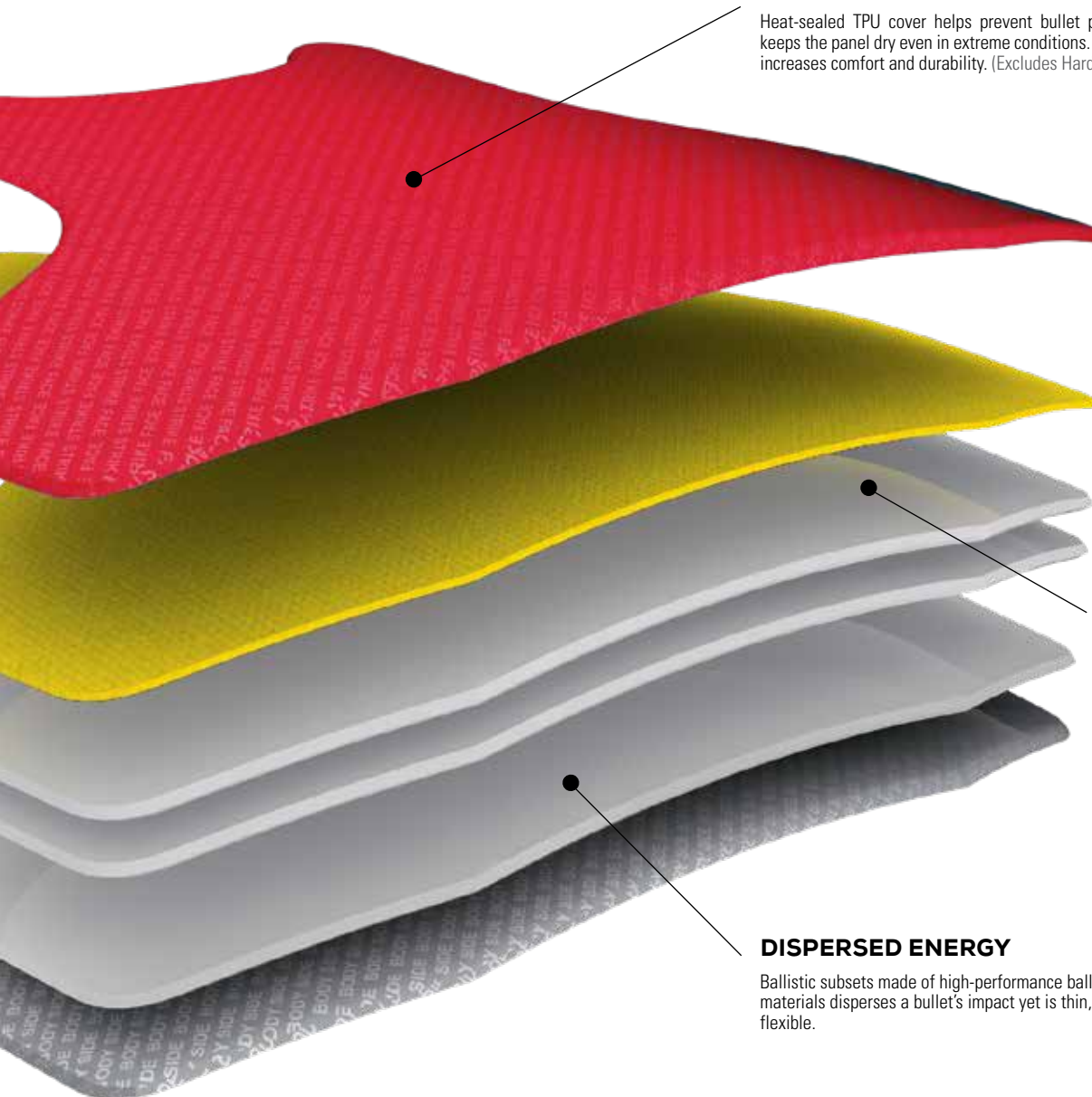



HARDWIRE ARMOR SYSTEMS

HARDWIRE®

This soft armor is a combination of perfectly interlaced multi-functional fibers and game changing polymer technology. Hardwire's proprietary manufacturing technology equates to the lightest armor in the world, with unprecedented stopping power.



Model	NIJ Model	Threat Type	Areal Density	Thickness	V50 (9mm)	V50 (.357 Mag)	V50 (.357 Sig)	V50 (.44 Mag)
Hardwire 68	HW-2015-10-SB	IIIA	0.68	0.18	-	-	1755	1661
Hardwire 74	HW-2015-09-SB	IIIA	0.74	0.19	-	-	1791	1634

Concealable Armor



SUMMIT™

Providing unparalleled comfort and a soft, flexible feel, this panel provides exceptional ballistic performance and reduces heat buildup with the use of advanced, exclusive materials. It is unsurpassed in providing heightened protection against an array of special threats.

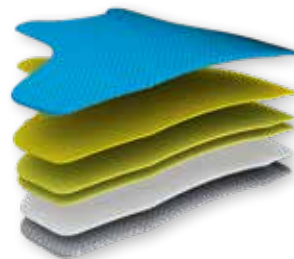

Model	NIJ Model	Threat Type	Areal Density	Thickness	V50 (9mm)	V50 (.357 Mag)	V50 (.357 Sig)	V50 (.44 Mag)
SM02	BA-2000S-SM02	II	0.79	0.190	1770	1676	-	-
SM02F	BA-2000S-SM02F	II	0.79	0.190	1717	1659	-	-
SM02	BA-3A00S-SM02	IIIA	1.04	0.250	-	-	1868	1720
SM02F	BA-3A00S-SM02F	IIIA	1.04	0.250	-	-	1863	1638



MATRIX®

One of our most economical ballistic packages. This package is an excellent choice for officers who demand the perfect balance of comfort, value and flexibility in a hybrid design.

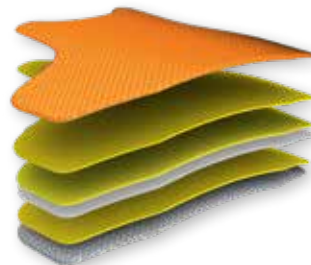

Model	NIJ Model	Threat Type	Areal Density	Thickness	V50 (9mm)	V50 (.357 Mag)	V50 (.357 Sig)	V50 (.44 Mag)
MR02	BA-2000S-MR02	II	0.89	0.212	1678	1625	-	-
MR02F	BA-3A00S-MR02	II	0.89	0.212	-	-	-	-
MR02	BA-3A00S-MR02	IIIA	1.20	0.290	-	-	1858	1697
MR02F	BA-3A00S-MR02	IIIA	1.20	0.290	-	-	1805	1603





PRISM® MT

Offers an unprecedented degree of protection against correctional threats. Combines several of the most advanced woven aramid corrections materials available for protection against circular penetrators and multi-threat protection for both stab and ballistic threats.

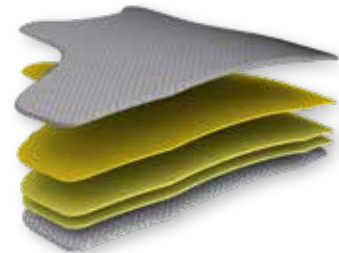

Model	NIJ Model	Threat Type	Areal Density	Thickness
Prism MT	MS-2020S-MT21	II / Spike 2	1.29	0.353
Prism MT	MS-2020S-MT22.1	II / Spike 2	1.08	0.260
Prism MT	MS-3A30S-MT01	IIIA / Spike	1.44	0.410



SX™

The thinnest, lightest and one of the strongest ballistic panels available. Born of breakthrough technologies and exclusive materials, SX offers unmatched performance for comfort, flexibility, durability and strength in a hybrid design.



Model	NIJ Model	Threat Type	Areal Density	Thickness	V50 (9mm)	V50 (.357 Mag)	V50 (.357 Sig)	V50 (.44 Mag)
SX02	BA-2000S-SX02	II	0.59	0.160	1817	1699	-	-
SX02F	BA-2000S-SX02F	II	0.61	0.165	1810	1699	-	-
SX02	BA-3A00S-SX02	IIIA	0.83	0.190	-	-	1912	1740
SX02F	BA-3A00S-SX02F	IIIA	0.85	0.20	-	-	1891	1670

DuPont™ **Kevlar** **Honeywell** —**SAATI**



XTREME®

Versatile and flexible, this high-performance ballistic panel delivers all-condition comfort with maximum stopping power. Designed to reduce trauma upon impact, it features a contoured, biomorphic design with advanced perimeter stitching to enhance performance.



Model	NIJ Model	Threat Type	Areal Density	Thickness	V50 (9mm)	V50 (.357 Mag)	V50 (.357 Sig)	V50 (.44 Mag)
XT03	BA-2000S-XT03	II	0.85	0.180	1680	1610	-	-
XT03F	BA-2000S-XT03F	II	0.85	0.180	1698	1671	-	-
XT03	BA-3A00S-XT03	IIIA	1.15	0.250	-	-	1822	1638
XT03F	BA-3A00S-XT03F	IIIA	1.15	0.250	-	-	1823	1659

Honeywell **TEXTECH** INDUSTRIES DuPont™ **Kevlar** —**SAATI**

COVERT CARRIERS

Ergonomic designs, lightweight fabrics and contoured stitch lines are the platform on which comfort and mobility are built into every covert carrier. From the ultra-concealable F1 to the premier features of the P1, these covert carriers are a sampling of how Safariland® Armor covers all the bases for fit, comfort, and performance.

P1

- Lightweight four-way stretch ripstop shell fabric
- High-performance spacer mesh liner
- Complementary lightweight spacer mesh liner for improved airflow
- Removable contoured ergonomic straps, with controlled stretch
- Front and back plate pockets
- Zip out front and back panels for easy accessibility with zipper garage
- Strategically located ergonomic VELCRO® Brand hook and loop channels for easy fastening and removal
- High-profile VELCRO® Brand hook and loop fasteners for extra strength and durability



BACK



M1

- Front and rear plate pockets
- Removable contoured ergonomic straps, with controlled stretch
- Durable hexagon ripstop shell fabric
- X-Static® silver anti-microbial wicking mesh liner
- Full row high-profile VELCRO® Brand hook and loop closures
- Strategically located ergonomic VELCRO® Brand hook and loop channels for easy fastening and removal



BACK





F1

- Second skin construction for ultra-concealability
- Ergonomic design for multi-directional mobility
- Pullover one-piece with no zippers
- Maximum comfort for all day use
- Internal side entry for easy panel insertion
- Lightweight compression
- Breathable high performance laminated four-way stretch fabric
- High-performance cooling spacer mesh liner
- Anti-bacterial odor-control finish



BACK

Overt Carriers

V1 CLEAN

- Custom clean laser-cut MOLLE loops allow for VIEVU® camera chest and shoulder placement
- Laser-cut webbing for mic attachment on shoulders
- Removable ID pull down tabs
- Custom configured embellishment options
- Front hidden pockets with internal mesh pockets
- Clamshell VELCRO® Brand hook and loop-adjustable shoulder closures
- Adjustable sides
- Quick access angled hidden gun pocket
- Front opening loading plate pocket
- Back top-loading plate pocket
- Discreet zippers for panel insertion
- Ribbed channel spacer cooling mesh throughout
- Back neck hidden drag strap
- Invista 100% Cordura® nylon - 500-denier
- Ergonomic textured zipper pulls
- Medical quality, soft, flexible, breathable cummerbund elastic



BACK



FRONT OPENING

SIDE OPENING

V1 WEBLESS

- Invista 100% Cordura® nylon - 500-denier
- Newly designed angular laser cut webbing for improved strength - AWS 2.0
- Clamshell VELCRO® Brand hook and loop-adjustable shoulder attachments
- Adjustable sides
- Front side opening loading plate pocket feature
- Back top-loading plate pocket
- Discreet zippers for panel insertion
- Ribbed channel spacer cooling liner mesh throughout
- High-profile VELCRO® Brand hook and loop for extra strength and durability
- Back neck hidden drag strap
- Ergonomic textured zipper pulls
- Medical quality, soft, flexible, breathable cummerbund elastic



BACK



FRONT OPENING

SIDE OPENING

Overt Carriers

V1

POCKET

- Clamshell VELCRO® Brand hook and loop-adjustable shoulder attachments
- Adjustable sides
- Hidden pockets with internal mesh pockets
- Front side opening loading plate pocket
- Back top-loading plate pocket
- Discreet zippers for panel insertion
- Front opening zipper design offers convenient on & off
- Ribbed channel spacer cooling mesh liner throughout
- High profile VELCRO® Brand hook and loop for extra strength and durability
- Back neck hidden drag strap
- Laser cut webless MOLLE loop pouches (Mag, Radio, OC Spray, Baton/Flashlight)
- Ultra lightweight durable construction
- Invista 100% Cordura® nylon - 500-denier
- Ergonomic textured zipper pulls
- Medical quality, soft, flexible, breathable cummerbund elastic



BACK



FRONT OPENING



SIDE OPENING

U1

UNIFORM

- Classic pin-tuck uniform pocket shirt design
- Soil-repellent 100% polyester shell fabric
- Front hidden pocket with additional internal mesh pockets
- Clamshell VELCRO® Brand hook and loop-adjustable shoulder attachments
- Adjustable sides
- Quick access angled hidden gun pocket
- Front side opening loading plate pocket
- Back top-loading plate pocket
- Discreet zippers for panel insertion
- Ribbed channel spacer cooling liner mesh throughout
- High-profile VELCRO® Brand hook and loop closure for extra strength and durability
- Back neck hidden drag strap



BACK



FRONT OPENING



SIDE OPENING

U1

POCKET

- Classic pin-tuck uniform pocket shirt design
- Soil-repellent 100% polyester shell fabric
- Clamshell VELCRO® Brand hook and loop-adjustable shoulder attachments
- Adjustable sides
- Front top-loading (Side opening)
- Back top-loading plate pocket
- Body-worn camera tab (optional)
- Fixed Pockets (Radio, Utility, Baton, Mag)
- Ribbed channel spacer cooling mesh liner throughout
- High-profile VELCRO® Brand hook and loop for extra strength and durability
- Back neck hidden drag strap



BACK



SIDE OPENING

**V1****EMS**

- Invista 100% Cordura® nylon - 500-denier
- Durable accessory pouches (Radio, Baton/Flashlight, Utility, Medical)
- Clamshell VELCRO® Brand hook and loop-adjustable shoulder attachments
- Adjustable sides
- Front side opening loading plate pocket feature
- Back top-loading plate pocket
- Discreet zippers for panel insertion
- Ribbed channel spacer cooling liner mesh throughout
- High-profile VELCRO® Brand hook and loop for extra strength and durability
- Back neck hidden drag strap
- Ergonomic textured zipper pulls
- Medical quality, soft, flexible, breathable cummerbund elastic

**V1****HI-VIS CLEAN**

- Invista 100% Cordura® nylon - 500-denier
- Clamshell VELCRO® Brand hook and loop-adjustable shoulder attachments
- Adjustable sides
- Front side opening loading plate pocket feature
- Back top-loading plate pocket
- Discreet zippers for panel insertion
- Front opening zipper design offers convenient on & off
- Ribbed channel spacer cooling liner mesh throughout
- High-profile VELCRO® Brand hook and loop for extra strength and durability
- Back neck hidden drag strap
- Quick access angled hidden gun pocket
- Ergonomic textured zipper pulls
- Medical quality, soft, flexible, breathable cummerbund elastic
- Front zipper opening and traditional side opening versions available



FIXED POCKET

WEBLESS

V1**FIREARMS INSTRUCTOR**

- Invista 100% Cordura® nylon - 500-denier
- Newly designed angular laser cut webbing for improved strength - AWS 2.0
- Clamshell VELCRO® Brand hook and loop-adjustable shoulder attachments
- Adjustable sides
- Front side opening loading plate pocket feature
- Back top-loading plate pocket
- Discreet zippers for panel insertion
- Front opening zipper design offers convenient on & off
- Ribbed channel spacer cooling liner mesh throughout
- High-profile VELCRO® Brand hook and loop for extra strength and durability
- Back neck hidden drag strap
- Quick access angled hidden gun pocket
- Ergonomic textured zipper pulls
- Medical quality, soft, flexible, breathable cummerbund elastic
- Front zipper opening and traditional side opening versions available

**V1****HI-VIS WEBLESS**

- Invista 100% Cordura® nylon - 500-denier
- Newly designed angular laser cut webbing for improved strength - AWS 2.0
- Clamshell VELCRO® Brand hook and loop-adjustable shoulder attachments
- Adjustable sides
- Discreet zippers for panel insertion
- Front side opening loading plate pocket feature
- Back top-loading plate pocket
- Ribbed channel spacer cooling liner mesh throughout
- High-profile VELCRO® Brand hook and loop for extra strength and durability
- Back neck hidden drag strap
- Quick access angled hidden gun pocket
- Ergonomic textured zipper pulls
- Medical quality, soft, flexible, breathable cummerbund elastic

T A C

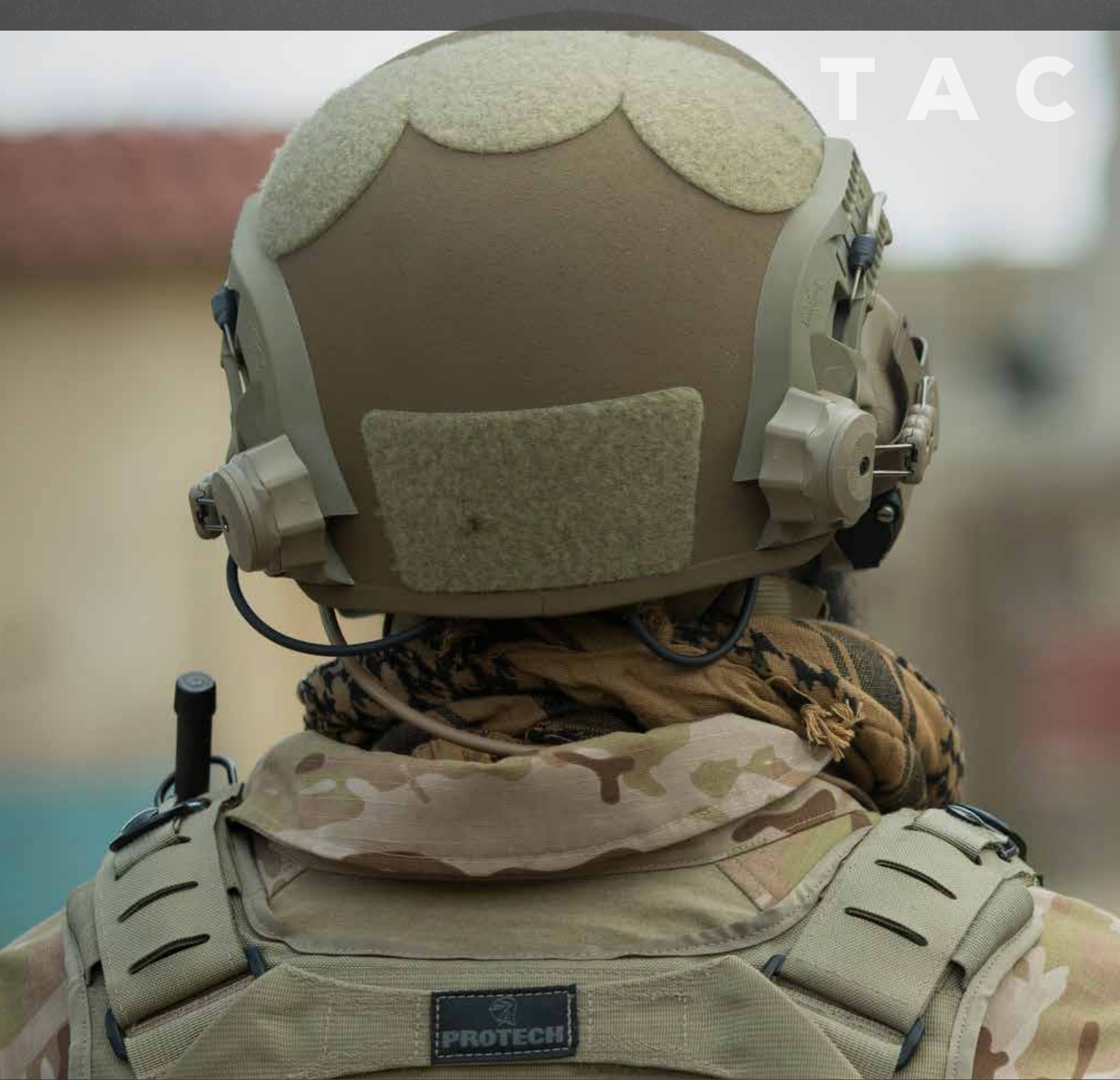

T I C A L A R M O R



PROTECH® Tactical - a brand synonymous with innovative designs and cutting edge technologies, brings some of the most well-known and recognized tactical products to the market. We strive to be the experts in tactical body armor, accessories and equipment, and push our products to the limits to do so. Staying ahead of the competition and accomplishing our goal of protecting the protectors, we collaborate with companies driven by the same passion for quality products and design ingenuity. **PROTECH** and its exclusive partners set the standard of quality and innovation across a range of products designed to perform and protect in the world's most demanding security environments.

PROTECH®

Technologies

Safariland Body Armor offers a full range of ballistic solutions with lightweight performance and value. NIJ Standard-0101.06 approved, these panels are special threat tested and feature dynamic material hybridization for optimum protection against a full array of threats.



SEE PAGE 33

Hardwire® Ballistic Technologies

In collaboration with Hardwire, LLC, PROTECH® Tactical offers their most coveted carriers and plate rack systems with the lightest Level IIIA body armor on the market, as well as lightweight Type III plates.



FirstSpear® 6/12™ LOAD-BEARING PLATFORM

Durable and lightweight, the laser cut slits of the 6/12™ technology provide an extremely lightweight option for the operator. This new offering expands our breadth of load-bearing platforms and is compatible with all pouches offered in the PROTECH® Tactical line.



FirstSpear® Tubes™ RAPID RELEASE CLOSURE SYSTEM

The Tubes™ closure is a highly sought-after rapid release system that utilizes polymer tubes for shoulder-to-carrier and cummerbund-to-carrier attachment points.



Blue Force Gear® Helium Whisper® POUCH BACKERS

Helium Whisper® is a revolutionary pouch attachment system that capitalizes on the lightweight and durable properties of state-of-the-art ULTRAcamp® material.



Blue Force Gear® ULTRAcamp®

A high-performance laminate utilized in a range of PROTECH Tactical products including AWS load-bearing platforms and LT pouch backers. Its hydrophilic feature allows products to stay dry and light, while exceeding military standard tear and abrasion standards.





SHOWN IN 6/12 FST VARIANT WITH OPTIONAL ID PATCH

SHIFT 360™

SCALABLE PLATE RACK SYSTEM

The Shift 360™ System is a sleek and innovative plate rack design that offers the operator ultimate scalability based on mission-specific requirements.

- Highest speed and most dynamic situational scalable plate rack on the market
- Features design refinements for increased fit, form and function such as cummerbund upgrades, reinforced attachment system and new closure system & load-bearing platform offerings

LOAD BEARING PLATFORM OPTIONS

- Advanced Webless System (AWS)
- FirstSpear® 6/12™ (6/12)
- Traditional Modular Webbing (TMW)

CLOSURE SYSTEM OPTIONS

- Shift 360 FirstSpear® Tubes™ (FST)
- Shift 360 Single-Point Quick Release (QRS)
- Shift 360 VELCRO® Brand Hook and Loop (VCS)

COLORS



OPTIONAL ACCESSORIES

Ballistic Internal Yoke, Ballistic Collar, Ballistic Shoulders, Ballistic Throat, Non-Ballistic Shoulders, Structured Upper Arms, Lower Abdomen/Spine, Ballistic Tactical Belt, Triple M4 Mag Carry Set, Ballistic Panel Inserts



FRONT SHOWN IN AWS QRS VARIANT



BACK SHOWN IN AWS FST VARIANT



SHOWN IN AWS BKL VARIANT

**TAC™ PR
PLATE RACK**

- Optimal first responder plate rack tried and true among domestic US agencies
- Adjustable cummerbund for additional accessory attachment and unrivaled speed donning with integrated pull-strap system
- 10"x12" front and back plate pockets featuring bottom-load orientation
- Officer extraction strap
- Interior padding for long-wear comfort

LOAD BEARING PLATFORM OPTIONS

- Advanced Webless System (AWS)
- Traditional Modular Webbing (TMW)

CLOSURE SYSTEM OPTIONS

- TAC PR Buckle Closure (BKL)

OPTIONAL ACCESSORIES

- Structured Upper Arms
- LT and TP Pouch Lines
- Ballistic Panel Inserts
- PROTECH Tactical Rifle Plates

COLORS



BLACK NAVY RANGER GREEN TAN MULTICAM® TACTICAL GREEN COYOTE



SHOWN IN TMW BKL VARIANT

TAC™ PH PLATE HARNESS

- Dynamic active shooter plate harness with design upgrades developed for enhanced fit, form and function
- 10" x 12" front and back plate pockets
- Adjustable shoulder straps
- Low-profile side buckle closure straps
- Keeper loops for excess side strap management
- Reinforced extraction strap

LOAD BEARING PLATFORM OPTIONS

- Traditional Modular Webbing (TMW)

CLOSURE SYSTEM OPTIONS

- TAC PH Buckle Closure (BKL)
- TAC PH FirstSpear® Tubes™ (FST)

OPTIONAL ACCESSORIES

- Structured Upper Arms
- LT and TP Pouch Lines
- Ballistic Panel Inserts (Shooters Cut Only)
- PROTECH® Tactical Shooters Cut Rifle Plates

COLORS



BLACK

NAVY

RANGER
GREEN

TAN

MULTICAM®

TACTICAL
GREEN

COYOTE



SHOWN IN 612 FST VARIANT

OPTIONAL ACCESSORIES

Ballistic Collar, Ballistic Throat, Structured Upper Arms, Lower Abdomen, Standard or Enhanced Groin, Spacer Mesh inserts (TMW model only), PROTECH Tactical Rifle Plates

FAST ATTACK VEST

- Versatile tactical platform for high-risk tactical operations offers a comprehensive panel array for the urban operator
- Front, back, shoulders and side panel array
- Front and rear plate pockets accommodate 10"x12" or Medium SAPI/Swimmers rifle plates
- Internal and external cummerbunds for a highly adjustable fit

LOAD BEARING PLATFORM OPTIONS

- Advanced Webless System (AWS)
- FirstSpear® 6/12™ (6/12)
- Traditional Modular Webbing (TMW)

CLOSURE SYSTEM OPTIONS

- Fast Attack FirstSpear® Tubes™ (FST)
- Fast Attack Single-Point Quick Release (QRS)
- Fast Attack VELCRO® Brand Hook and Loop (VCS)

COLORS



FRONT
SHOWN IN AWS VCS VARIANT



BACK
SHOWN IN AWS FST VARIANT



SHOWN IN AWS FST VARIANT

TITAN™ ASSAULT VEST

- A full-coverage vest designed for entry teams with the ability to add protection with a host of ballistic accessories
- External front & back plate pockets accommodate 8"x10" and 10"x12" plates
- External top-loading 12"x8.5" auxiliary dump pouch
- AWS model features a low-profile front platform due to a shortened cummerbund length
- Hidden integrated dual wire channel
- Built-in mic tabs
- Reinforced rescue strap

LOAD BEARING PLATFORM OPTIONS

- Advanced Webless System (AWS)
- Traditional Modular Webbing (TMW)

CLOSURE SYSTEM OPTIONS

- Titan Assault FirstSpear® Tubes™ (FST)
- Titan Assault VELCRO® Brand Hook and Loop (VCS)

COLORS



FRONT
SHOWN IN AWS VCS VARIANT



BACK
SHOWN IN AWS VCS VARIANT

OPTIONAL ACCESSORIES

Ballistic Collar, Ballistic Throat, Structured Upper Arms, Standard or Enhanced Groin, Spacer Mesh inserts (TMW model only), PROTECH Tactical Rifle Plates





SHOWN IN 612 FST VARIANT

ALL PURPOSE VEST

- BALCS US military shape provides a perfect balance of maneuverability and coverage
- 10"x12" or SAPI front and back plate pockets with bottom load orientation
- External top-loading auxiliary pouch
- Available in 8 sizes
- Highly adjustable cummerbund closure system

LOAD BEARING PLATFORM OPTIONS

- Advanced Webless System (AWS)
- FirstSpear® 6/12™ (6/12)
- Traditional Modular Webbing (TMW)

CLOSURE SYSTEM OPTIONS

- All Purpose Vest FirstSpear® Tubes™ (FST)
- All Purpose Vest Single-Point Quick Release (QRS)
- All Purpose Vest VELCRO® Brand Hook and Loop (VCS)

COLORS



FRONT
SHOWN IN AWS VCS VARIANT



BACK
SHOWN IN AWS VCS VARIANT

OPTIONAL ACCESSORIES

Ballistic Internal Yoke, Ballistic Collar, Ballistic Throat, Ballistic Shoulders, Non-ballistic Shoulder Pads, Structured Upper Arms, PROTECH Tactical Rifle Plates, Ballistic Groin

Ballistic Panels

Safariland Body Armor offers a full range of ballistic solutions with lightweight performance and value. NIJ Standard-0101.06 approved, these panels are special threat tested and feature dynamic material hybridization for optimum protection against a full array of threats.

HARDWIRE®

This soft armor is a combination of perfectly interlaced multi-functional fibers and game changing polymer technology. Hardwire's proprietary manufacturing technology equates to the lightest armor in the world, with unprecedented stopping power.

Model	NIJ Model	Threat Type	Areal Density	Thickness	V50 (9mm)	V50 (.357 Mag)	V50 (.357 Sig)	V50 (.44 Mag)
Hardwire 68	HW-2015-10-SB	IIIA	0.68	0.18	-	-	1755	1661
Hardwire 74	HW-2015-09-SB	IIIA	0.74	0.19	-	-	1791	1634



SX™

The thinnest, lightest and one of the strongest ballistic panels available. Born of breakthrough technologies and exclusive materials, SX offers unmatched performance for comfort, flexibility, durability and strength in a hybrid design.

Model	NIJ Model	Threat Type	Areal Density	Thickness	V50 (9mm)	V50 (.357 Mag)	V50 (.357 Sig)	V50 (.44 Mag)
SX02	BA-2000S-SX02	II	0.59	0.160	1817	1699	-	-
SX02	BA-3A00S-SX02	IIIA	0.83	0.190	-	-	1912	1740



SUMMIT™

Providing unparalleled comfort and a soft, flexible feel, this panel provides exceptional ballistic performance and reduces heat buildup with the use of advanced, exclusive materials. It is unsurpassed in providing heightened protection against an array of special threats.

Model	NIJ Model	Threat Type	Areal Density	Thickness	V50 (9mm)	V50 (.357 Mag)	V50 (.357 Sig)	V50 (.44 Mag)
SM02	BA-2000S-SM02	II	0.79	0.190	1770	1676	-	-
SM02	BA-3A00S-SM02	IIIA	1.04	0.250	-	-	1868	1720



XTREME®

Versatile and flexible, this high-performance ballistic panel delivers all-condition comfort with maximum stopping power. Designed to reduce trauma upon impact, it features a contoured, biomorphic design with advanced perimeter stitching to enhance performance.

Model	NIJ Model	Threat Type	Areal Density	Thickness	V50 (9mm)	V50 (.357 Mag)	V50 (.357 Sig)	V50 (.44 Mag)
XT03	BA-2000S-XT03	II	0.85	0.180	1680	1610	-	-
XT03	BA-3A00S-XT03	IIIA	1.15	0.250	-	-	1822	1638



MATRIX™

The Matrix ballistic panel is one of our most economical ballistic packages. This package is an excellent choice for officers who demand the perfect balance of comfort, value and flexibility in a hybrid design.

Model	NIJ Model	Threat Type	Areal Density	Thickness	V50 (9mm)	V50 (.357 Mag)	V50 (.357 Sig)	V50 (.44 Mag)
MR02	BA-2000S-MR02	II	0.89	0.212	1678	1625	-	-
MR02	BA-3A00S-MR02	IIIA	1.20	0.290	-	-	1858	1697



Tactical Soft Accessories

BUILD YOUR ARMOR SYSTEM BALLISTIC PROTECTION WITH OPTIONAL ACCESSORIES

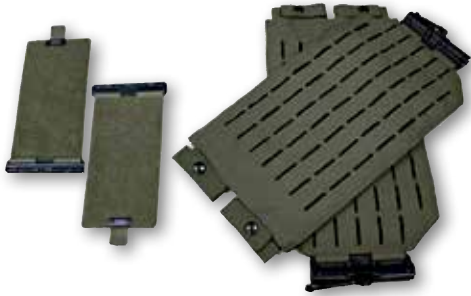

FIRSTSPEAR® TUBES™ RETROFIT CUMMERBUND KIT
AVAILABLE FOR SHIFT 360, ALL PURPOSE VEST AND FAST ATTACK VEST MODELS



BALLISTIC THROAT PROTECTOR



BALLISTIC GROIN PROTECTOR



STRUCTURED UPPER ARM PROTECTORS



TACTICAL BALLISTIC BELT



LOWER ABDOMEN/SPINE PROTECTOR

CANINE ARMOR

Canine Armor

BARK-9™ HIGH-SPEED CANINE ARMOR SYSTEM

- Designed for the modern K-9 officer with features to suit today's modern police, SWAT or special operations canine
- Reinforced stitching for durability
- Restraint handle and D-rings for adjustable leash attachment
- Hook and loop ID attachment platforms
- Additional modular webbing for video/surveillance equipment attachment
- Rugged 500-denier Cordura® nylon and long-lasting wear
- Detachable spine extension (2" of ballistic overlap)
- Various ballistic packages available
- Sizes Small to X-Large





AMMUNITION LINE OF POUCHES SHOWN ABOVE

POUCH BACKERS

Available in two options: traditional MOLLE web attachment on durable Cordura® nylon pouches, and First Spear's Helium Whisper® MOLLE attachment with its high-performance wear- and tear-resistant ULTRA-comp™ laminate material.



CORDURA® NYLON POUCH BACKERS



HELIUM WHISPER POUCH BACKERS

AMMUNITION / MAGAZINE POUCHES

- TP1 P90 Magazine Pouch, Double
- TP2 UMP 45 Magazine Pouch, Double
- TP3 MP5 Magazine Pouch, Double
- TP4 M4 Magazine Pouch, Double, Stacked
- TP4A M4 Magazine Pouch, Double, Staggered
- TP4B M4 Magazine Pouch, Double, Tango Down
- TP5 M4 Magazine Pouch, Single
- TP5A M4 Magazine Pouch, Double
- TP5B M4 Magazine Pouch, Triple
- TP6 M4 Magazine Pouch, Short, Single
- TP6A M4 Magazine Pouch, Short, Double
- TP6B M4 Magazine Pouch, Short, Triple
- TP7 M4/Side Arm Magazine Pouch, Dual/Double
- TP8 MP5/Side Arm Magazine Pouch, Dual/Double
- TP9 SR25 Magazine Pouch, Single
- TP9A SR25 Magazine Pouch, Double
- TP10 Side Arm Magazine Pouch, Single
- TP10A Side Arm Magazine Pouch, Double
- TP10B Side Arm Magazine Pouch, Triple
- TP11 12 Round Shot Shell Pouch
- TP11A 24 Round Shot Shell Pouch

LESS LETHAL POUCHES

- TP12 37/40 mm Less Lethal Pouch, Single
- TP12A 37/40 mm Less Lethal Pouch, Double
- TP12B 37/40 mm Less Lethal Pouch, Triple
- TP12C 37/40 mm Less Lethal Pouch, 7 Round
- TP12D 37/40 mm Less Lethal Pouch, 7 Round, Flip Down
- TP13 MK3/MK4 Aerosol Pouch
- TP15 Grenade Pouch, Single
- TP15A Grenade Pouch, Double
- TP16 #25 Distraction Device® Pouch, Single

UTILITY/MISCELLANEOUS POUCHES

- TP14 Expandable Baton/Flashlight Pouch, Single
- TP14A Expandable Baton/Flashlight Pouch, Double
- TP14B 26" Expandable Baton Pouch, Single
- TP14C Pelican 7060 Flashlight Pouch, Single
- TP17 Handcuff Pouch, Single
- TP17A Handcuff Pouch, Double
- TP18 Gas Mask Pouch
- TP19 Utility Pouch, 8" X 8"
- TP19A Utility Pouch, 4" X 8", Vertical
- TP19B Utility Pouch, 4" X 8", Horizontal
- TP20 Medical Pouch
- TP21 Radio Pouch, Universal
- TP21A Radio Pouch w/ Bungee, Universal
- TP22 Hydration Pouch
- TP22A Hydration Pouch, Nalgene
- TP22B Hydration Bladder, 2.5L
- TP23 Modular Webbing Adapter Platform
- TP24 6" X 6" Side Plate Pouch
- TP31 Medical Shears Pouch
- TP32 Dump Pouch, Stowable
- TP33 Tourniquet Pouch

SET OF SIX (6) POUCHES

(MUST BE ORDERED W/ TACTICAL VEST OR PLATE RACK)
Set of Any Six (6) Pouches

Tactical Equipment

PORTAL LADDER

- The Portal Ladder™ is a unique foldable ladder that provides mission flexibility and versatility to tactical teams
- Portable – hand carry strap allows for quick and easy movement through confined spaces. Backpack harness allows for hands-free carrying
- Night use/vision compatible
- Non-conductive composite material

Available in 5 height offerings:

- | | |
|-----------------|-----------------|
| 6 ft – 21 lbs. | 12 ft – 42 lbs. |
| 8 ft – 28 lbs. | 14 ft – 49 lbs. |
| 10 ft – 35 lbs. | |

PORTAL Ladder



PATENT PENDING



WEAPONS TRUNK BOX

WITH TYPE IIIA BALLISTIC SHIELD LID

The PROTECH® Tactical Weapons Trunk Box features a type IIIA ballistic shield which is integrated into the box as the lid. Fleet-friendly, the weapons trunk box allows for secure long-arm weapon storage, with the larger trunk accommodating other mission-specific gear such as helmets and plate racks.

- Offered in a standard 36" x 16" with the options of a 7" height (36 lb. total weight/14 lb. shield) or 12" height (49 lb. total weight/14 lb. shield)
- Key lock or 3-digit rotary combination
- Side ventilation holes
- Collapsible/spring-loaded rubber padded carry handles
- Full length tongue and groove rear hinge strength and weight standards for Class 1A working load rating of 300 lbs.



Hard Armor Plates

Safariland offers an extensive range of PROTECH® tactical armor plates designed to increase your protection with virtually any vest configuration or threat. Our independently tested, NIJ-0101.06 certified and NIJ-0101.04/05 tested line of single and multi-curve rifle plates are available in a variety of cuts.

NIJ-0101.06 CERTIFIED

Made in the **USA**



DT106E TYPE III

2113MC-3 TYPE III

HARDWIRE MC TYPE III

2014MC TYPE IV

9812-R1 TYPE IV

PROTECH® Hard Armor Plates (NIJ 0101.06 Type III) 7.62 mm x 51 mm, 147 gr., FMJ (NATO) (M80 Military Designation) - 6 Shots

NEW

Model	Size (approx.)	Weight (approx.)	Thickness (approx.)	Curvature / Cut	Armor Materials / Construction	Special Threat Testing (Independent NIJ Laboratory)	
DT106E	10" X 12" (25.4cm x 30.5 cm)	2.80 lbs (1.27 kg)	1.2 in. (3.05 cm)	Multi/Shooters	Polyethylene	<ul style="list-style-type: none"> • 7.62 x 39mm, 123 gr. MSC • 5.56 x 45mm, 55 gr. M193 	
	8" X 10" (20.3cm x 25.4cm)	2.05 lbs (.93 kg)		Multi/Rectangle			
	8.75" x 11.75" (22.2cm x 29.8cm)	2.51 lbs. (1.14 kg)		Multi/SAPI			
	9.5" x 12.5" (24.1cm x 31.7cm)	2.91 lbs. (1.33 kg)					
	10.25" x 13.25" (25.7cm x 33.6cm)	3.30 lbs. (1.5 kg)					
	11" x 14" (27.94 cm x 35.56 cm)	3.81 lbs. (1.73 kg)					
2113MC-3	10" X 12" (25.4cm x 30.5 cm)	3.2 lbs (1.4 kg)	1.14 in. (2.9 cm)	Multi/Shooters	Polyethylene	<ul style="list-style-type: none"> • 7.62 x 39 mm, 123 gr., MSC • 5.56 x 45mm, 55 gr. M193 	
	10" X 12" (25.4cm x 30.5 cm)	3.5 lbs (1.5 kg)		Multi/Rectangle			
	8" X 10" (20.3cm x 25.4cm)	2.3 lbs. (1.0 kg)		Multi/SAPI			
	8.75" x 11.75" (22.2cm x 29.8cm)	2.87 lbs. (1.3 kg)					
	9.5" x 12.5" (24.1cm x 31.7cm)	3.30 lbs. (1.5 kg)					
	10.25" x 13.25" (25.7cm x 33.6cm)	3.77 lbs. (1.5 kg)					
Hardwire® Multi-Curve	10" X 12" (25.4cm x 30.5 cm)	3.2 lbs. (1.4 kg)	1.25 in. (3.2 cm)	Multi/Shooters	Polyethylene		
	10" X 12" (25.4cm x 30.5 cm)	3.5 lbs. (1.58 kg)		Multi/Rectangle			
	8" X 10" (20.3cm x 25.4cm)	2.3 lbs. (1.0 kg)					
NEW HW-LWP-III	8.75" x 11.75" (22.2cm x 29.8cm)	1.95 lbs. (0.88 kg)	1.0 in. (2.54 cm)	Multi/SAPI	Polyethylene/	<ul style="list-style-type: none"> • 7.62 x 39mm, 123 gr. MSC • 5.56 x 45mm, 55 gr. M193 	
	9.5" x 12.5" (24.1cm x 31.7cm)	2.25 lbs. (1.02 kg)					
	10.25" x 13.25" (25.7cm x 33.6cm)	2.59 lbs. (1.17 kg)					
	11" x 14" (27.9cm x 35.5cm)	2.99 lbs. (1.36 kg)		Multi/Shooters			
	10" X 12" (25.4cm x 30.5 cm)	2.16 lbs. (10.98 kg)					
	10" X 12" (25.4cm x 30.5 cm)	2.26 lbs. (1.03 kg)					Multi/Rectangle
	8" X 10" (20.3cm x 25.4cm)	1.64 lbs. (0.74 kg)					
NEW HW-ICW-III-HBA	8.75" x 11.75" (22.2cm x 29.8cm)	3.35 lbs. (1.51 kg)	1.0 in. (2.54 cm)	Multi/SAPI	Ceramic/Polyethylene	<ul style="list-style-type: none"> • 7.62 x 39 mm, 123 gr. MSC • 5.56 x 45mm, 55 gr. M193 • 5.56 x 45 mm, 62 gr. M855 • 5.56 x 45mm, 62 gr. M855 Green Tip (SS109) 	
	9.5" x 12.5" (24.1cm x 31.7cm)	3.87 lbs. (1.76 kg)					
	10.25" x 13.25" (25.7cm x 33.6cm)	4.45 lbs. (2.02 kg)					
	11" x 14" (27.9cm x 35.5cm)	5.14 lbs. (2.33 kg)					

Hardwire ICW plates must be worn in-conjunction with Hardwire soft body armor - refer to product specification for details.

Hard Armor Plates

PROTECH® Hard Armor Plates (NIJ 0101.06 Type III)

(CONTINUED)

PROTECH® Hard Armor Plates (NIJ 0101.06 Type III) 7.62 mm x 51 mm, 147 gr., FMJ (NATO) (M80 Military Designation) - 6 Shots

Model	Size (approx.)	Weight (approx.)	Thickness (approx.)	Curvature / Cut	Armor Materials / Construction	Special Threat Testing (Independent NIJ Laboratory)
DT306C	10" X 12" (25.4cm x 30.5 cm)	4.0 lbs (1.8 kg)	1.0 in. (2.5 cm)	Multi/Shooters	Ceramic/ Polyethylene/	<ul style="list-style-type: none"> • 7.62 x 39mm, 123 gr. MSC • 5.56 x 45mm, 62 gr. M855 [SS109] • 5.56 x 45mm, 55 gr. M193 • 5.56 x 45mm, 62 gr. M855 Green Tip (SS109)
	8" X 10" (20.3cm x 25.4cm)	2.96 lbs (1.34 kg)		Multi/Rectangle		
	8.75" x 11.75" (22.2cm x 29.8cm)	3.6 lbs (1.6 kg)		Multi/SAPI		
	9.5" x 12.5" (24.1cm x 31.7cm)	4.2 lbs (1.9 kg)				
	10.25"x13.25" (25.7cm x 33.6cm)	4.8 lbs (2.1 kg)				
	11"x14" (27.9cm x 35.5cm)	5.4 lbs (2.4 kg)				
DT206C	8.75" x 11.75" (22.2cm x 29.8cm)	3.68 lbs (1.67 kg)	1.2 in. (3.05 cm)	Multi/SAPI	Ceramic/ Polyethylene/	<ul style="list-style-type: none"> • 7.62 x 39mm, 123 gr. MSC • 5.56 x 45mm, 55 gr. M193 • 5.56 x 45mm, 62 gr. M855 • 5.56 x 45mm, 62 gr. M855 Green Tip (SS109)
	9.5" x 12.5" (24.1cm x 31.7cm)	4.3 lbs (1.95 kg)				
	10.25"x13.25" (25.7cm x 33.6cm)	4.84 lbs (2.2 kg)				
	11"x14" (27.9cm x 35.5cm)	5.58 lbs (2.53 kg)		Multi/Shooters		
	10" X 12" (25.4cm x 30.5 cm)	4.11 lbs (1.86 kg)				
	8" X 10" (20.3cm x 25.4cm)	3.01 lbs (1.37 kg)				
DT306P	8.75" x 11.75" (22.2cm x 29.8cm)	1.86 lbs (0.84 kg)	1.0 in. (2.54 cm)	Multi/SAPI	Polyethylene/	<ul style="list-style-type: none"> • 7.62 x 39mm, 123 gr. MSC • 5.56 x 45mm, 55 gr. M193
	9.5" x 12.5" (24.1cm x 31.7cm)	2.2 lbs (1.0 kg)				
	10.25"x13.25" (25.7cm x 33.6cm)	2.53 lbs (1.10 kg)				
	11"x14" (27.9cm x 35.5cm)	2.92 lbs (1.32 kg)		Multi/Shooters		
	10" X 12" (25.4cm x 30.5 cm)	2.18 lbs (0.99 kg)				
	8" X 10" (20.3cm x 25.4cm)	1.41 lbs (0.64 kg)				
2120-5	10" X 12" (25.4cm x 30.5 cm)	5.8 lbs. (2.6 kg)	0.95 in. (2.4 cm)	Multi/Shooters	Ceramic/ Polyethylene/Fiberglass	<ul style="list-style-type: none"> • 7.62 x 54Rmm, 150 gr. LPS [Rimmed] • 7.62 x 51mm, 180 gr. PSP [300 Win. Mag] • 7.62 x 39mm, 123 gr. MSC • 5.56 x 45mm, 62 gr. Bonded SP • 5.56 x 45mm, 62 gr. M855 Green Tip [SS109] • 5.56 x 45mm, 55gr. M193 • 5.56 x 45mm, 62 G. M855 A1
	8" X 10" (20.3cm x 25.4cm)	4.6 lbs. (2.1 kg)		Multi/Rectangle		

PROTECH® Hard Armor Plates (NIJ 0101.06 Type IV) 7.62 mm x 63 mm, 166 gr., AP, (30-06) (M2 AP Military Designation) - 1 Shot

Model	Size (approx.)	Weight (approx.)	Thickness (approx.)	Curvature / Cut	Armor Materials / Construction	Special Threat Testing (Independent NIJ Laboratory)
2014MC	10" x 12" (25.4cm x 30.5cm)	7.7 lbs. (3.5kg)	0.99 in. (2.50 cm)	Multi/Shooters	Ceramic/ Glass Composite	• 7.62 x 54R B32, API (2 Shots)
	10" x 12" (25.4cm x 30.5cm)	8.5 lbs. (3.8kg)		Multi/Rectangle		
	8" X 10" (20.3cm x 25.4cm)	5.7 lbs. (2.6kg)				

PROTECH Hard Armor Plates (NIJ 0101.04 Type IV) 7.62 mm x 63 mm, 166 gr., FMJ M2 AP – 1 Shot

Model	Size (approx.)	Weight (approx.)	Thickness (approx.)	Curvature / Cut	Armor Materials / Construction	Special Threat Testing (Independent NIJ Laboratory)
9812-R1	9.5" x 12.5" (24.1cm x 31.7cm)	5.4 lbs. (2.45 kg)	0.75 in. (1.91cm)	Multi/SAPI	Ceramic/Polyethelene	• 7.62mm x 39mm, 120 gr. API BZ-5



TYPE IV MINI SIDE PLATE



TYPE III MINI SIDE PLATE



ICW MINI SIDE PLATE

PROTECH® Mini Side & Independently Tested Stand Alone Plates (Non-Certified)

Model	Size (approx.)	Weight (approx.)	Thickness (approx.)	Curvature / Cut	Armor Materials / Construction	Special Threat Testing (Independent NIJ Laboratory)
9812-R1	6" X 8" (15.2cm x 20.3cm)	2.2 lbs. (1.0 kg)	0.75 in. (1.9 cm)		Ceramic/ Polyethylene	<ul style="list-style-type: none"> • 7.62 x 63mm, 166 gr. AP(30-06)(M2 AP)
	6" X 6" (15.2cm x 15.2cm)	1.6 lbs. (0.7 kg)				
2120	6" X 6" (15.2cm x 15.2cm)	1.9 lbs. (0.9 kg)	0.81 in. (2.1 cm)		Ceramic/ Polyethylene	<ul style="list-style-type: none"> • 7.62 x 51mm, 147 gr. FMJ [NATO][M80] • 7.62 x 39mm, 123 gr. MSC • 7.62 x 54Rmm, 150 gr. LPS • 7.62 x 51mm, 180 gr. PSP • 5.56 x 45mm, 62 gr. M855 Green Tip (SS109) • 7.62 x 51mm, 147 gr. FMJ [NATO][M80]
2113	6" X 6" (15.2cm x 15.2cm)	1.1 lbs. (0.5 kg)	1.14 in. (2.89 cm)		Polyethylene	<ul style="list-style-type: none"> • 7.62 x 51mm, 147 gr. FMJ [NATO][M80]
Hardwire MC	6" X 6" (15.2cm x 15.2cm)	1.0 lbs. (0.45 kg)	1.25 in. (3.2 cm)			
2014	6" X 6" (15.2cm x 15.2cm)	2.6 lbs. (1.2kg)	0.99 in. (2.5cm)		Ceramic / Polyethylene	<ul style="list-style-type: none"> • 7.62 x 63mm, 166 gr. AP (30-06) (M2 AP)

Hard Armor Plates

INDEPENDENTLY TESTED

X-CAL™



X-CAL LP



X-CAL US

X-CAL™ LP In-Conjunction With (ICW) Special Threat Plates

Model	Size (approx.)	Weight (approx.)	Thickness (approx.)	Curvature / Cut	Armor Materials / Construction	Special Threat Testing (Independent NIJ Laboratory)
X-CAL-LP	10" x 12" (25.4cm x 30.5cm)	5.5 lbs. (2.5 kg)	0.43 in. (1.09cm)	Multi/ Shooters	Ceramic Composite	<ul style="list-style-type: none"> • 5.56 x 45mm, 62 gr. M855 Green Tip (SS109) • 7.62mm x 39mm, 123 gr. MSC • 7.62mm x 39mm, 119 gr. API BZ • 7.62mm x 54Rmm, 150 gr. LPS FMJ (Exception with XT03 Type II Package) • 7.62mm x 51mm, 147 gr. FMJ [NATO][M80] • 5.56 x 45mm, 55 gr. M193
	7" x 9" (17.78cm x 22.86cm)	3.3 lb. (1.5kg)		Single / Rectangle		
	5" x 8" (12.7cm x 20.32cm)	2.2 lb. (1kg)				
	6" x 6" (15.2cm x 15.2cm)	1.8 lbs. (0.8kg)				

X-CAL™ US In-Conjunction-With (ICW) NIJ 0101.04 Type III Plates

Model	Size (approx.)	Weight (approx.)	Thickness (approx.)	Curvature / Cut	Armor Materials / Construction	Special Threat Testing (Independent NIJ Laboratory)
X-CAL US	10" x 12" (25.4cm x 30.5cm)	3.7 lbs. (1.7 kg)	0.75 in. (2.0cm)	Multi/Shooters	Ceramic / Polyethylene	<ul style="list-style-type: none"> • 5.56 x 45mm, 55 gr. M193 • 5.56 x 45mm, 62 gr. M855 Green Tip (SS109) • 7.62 x 39mm, 123 gr. MSC • 7.62 x 51mm, 147 gr. [NATO][M80]
	8" x 10" (20.3cm x 25.4cm)	2.6 lbs. (1.2 kg)		Multi/Rectangle		
	10.25" x 13.25" (26.7cm x 33.7cm)	4.4 lbs. (2.0 kg)		Multi/SAPI		
	9.5" x 12.5" (24.1cm x 31.8cm)	3.9 lbs. (1.8 kg)				
	8.75" x 11.75" (22.2cm x 29.8cm)	3.3 lbs. (1.5 kg)				
	11" x 14" (27.94 cm x 35.56 cm)	5.1 lbs. (2.3 kg)		Single/Rectangle		
	6" x 6" (15.2cm x 15.2cm)	1.1 lbs. (0.5kg)				

INDEPENDENTLY TESTED Hardwire In-Conjunction-With (ICW) Special Threat Plates

NEW

Model	Size (approx.)	Weight (approx.)	Thickness (approx.)	Curvature / Cut	Armor Materials / Construction	Special Threat Testing (Independent NIJ Laboratory)
HW-ICW-III	8.75" x 11.75" (22.2cm x 29.8cm)	3.35 lbs. (1.15 kg)	1.0 in. (2.54 cm)	Multi/SAPI	Ceramic/Polyethelene	<ul style="list-style-type: none"> • 7.62mm x 39mm, 123 gr. MSC • 5.56 mm x 45 mm, 55 gr. M193 • 5.56 x 45mm, 62 gr. M855 Green Tip (SS109) • 7.62 mm x 51 mm, 147 gr., FMJ (NATO) (M80)
	9.5" x 12.5" (24.1cm x 31.7cm)	3.87 lbs. (1.76 kg)				
	10.25" x 13.25" (25.7cm x 33.6cm)	4.45 lbs. (2.02 kg)				
	11" x 14" (27.9cm x 35.5cm)	5.4 lbs. (2.45 kg)				

X-CAL and Hardwire ICW plates must be worn in-conjunction with Safariland soft flexible body armor - refer to product specification for details.

Special Threat Plates



IMPAC™

IMPAC™ Special Threat Plates (Non-Certified)

Model	Size (approx.)	Weight (approx.)	Thickness (approx.)	Curvature / Cut	Armor Materials / Construction	Special Threat Testing (Independent NIJ Laboratory)
IMPAC-HT (Handgun Threats)	5" x 7" (12.7cm x 17.78cm)	0.25 lb. (0.11kg)	0.25 in. (0.64cm)	Single/ Rectangle	Polyethylene	<ul style="list-style-type: none"> • Speer .357 SIG FMJ FN (3 Shots) • Speer .44 Mag SJHP (1 Shot) • Winchester Ranger 9mm +P+ 127 gr. SXT (3 Shots) • Speer .357 SIG 125 gr. Gold Dot HP (3 Shots) • Norinco 7.62mm Tokarev, 85 gr. FMJ (3 Shots) • FN 5.7mm x 28mm SS197 (Blue Tip) 40 gr. (3 Shots) • FN 5.7mm x 28mm SS195 L.F. (Belgium) 28 gr. JHP (3 Shots)
	5" x 8" (12.7cm x 20.32cm)	0.30 lb. (0.14kg)				
	7" x 9" (17.78cm x 22.86cm)	0.50 lb. (0.20kg)		Single/ Shooters		
	10" x 12" (25.4cm x 30.5cm)	0.70 lb. (0.32kg)		Single/Rectangle		
	10" X 12" (25.4cm x 30.5cm)	0.80 lb. (0.40 kg)		Single/Upper Arm		
	7" X 8" (17.7cm x 20.3cm)	0.45 lb. (0.20 kg)				
IMPAC-HT1 (Handgun / Spike 1 Threats)	5" x 7" (12.7cm x 17.78cm)	0.4 lb. (0.2kg)	0.3 in. (0.76cm)	Single/ Rectangle	Stainless Steel/ Unidirectional Polyethylene	<ul style="list-style-type: none"> • Speer .357 SIG, 125 gr. FMJ (3 Shots) • Speer .44 Mag, 240 gr. SJHP (1 Shots) • Winchester Ranger 9mm +P+ 127 gr. SXT (3 Shots) • Speer .357 SIG 125 gr. Gold Dot HP (3 Shots) • Norinco 7.62mm Tokarev, 85 gr. FMJ (3 Shots) • FN 5.7mm x 28mm, 28 gr. SS19F (Belgium) (3 Shots) • FN 5.7mm x 28mm, 40 gr. SS197 (Blue Tip) (3 Shots) • Spike Protection Level 1 • 24 J – Strike Energy • 36 J – Over test Strike Energy
	5" x 8" (12.7cm x 20.32cm)	0.5 lb. (0.22kg)				
	7" x 9" (17.78cm x 22.86cm)	0.6 lb. (0.3kg)		Single/ Shooters		
	10" x 12" (25.4cm x 30.5cm)	0.9 lb. (0.4kg)				
IMPAC CT/DT Correctional/ Duty Threats	5" x 7" (12.7cm x 17.7cm)	0.52 lbs. (0.24 kg)	0.2 in. (0.5 cm)	Single/Rectangle	Fiberglass Composite	<ul style="list-style-type: none"> • American Eagle 9mm, 115 gr. FMJ (3 Shots) • .40 S&W Ranger, 165 gr. SXT (3 Shots) • Federal .45 ACP, 230 gr. HST +P (3 Shots) • Spike Instrument @ Protection Level 3 for E1 Strike/E2 Overstrike (3 Drops) • P1 Edged Blade @ Protection Level 3 for E1 Strike/E2 Overstrike (3 Shots) • S1 Edged Blade @ Protection Level 3 for E1 Strike/E2 Overstrike (3 Shots)
	5" x 8" (12.7cm x 20.3cm)	0.57 lbs. (0.26 kg)				
	7" x 9" (17.7cm x 22.9cm)	0.83 lbs. (0.37 kg)		Single/Shooters		
	10" x 12" (25.4cm x 30.5cm)	1.38 lbs. (0.62 kg)				
IMPAC MT Multi-Threats	5" x 7" (12.7cm x 17.7cm)	0.73 lbs. (0.33 kg)	0.4 in. (1.0 cm)	Single/Rectangle	Fiberglass Composite	<ul style="list-style-type: none"> • Speer .357 SIG FMJ FN (3 Shots) • Speer .44 Mag SJHP (1 Shot) • Winchester Ranger 9 mm +P+ 127 gr. SXT (3 Shots) • Speer .357 SIG 125 gr. Gold Dot HP (3 Shots) • Norinco 7.62 mm Tokarev, 85 gr. FMJ (3 Shots) • FN 5.7 mm x 28 mm SS197 (Blue Tip) 40 gr. (3 Shots) • FN 5.7 mm x 28 mm SS195 L.F. (Belgium) 28 gr. JHP (3 Shots) • Aquila IQ 9mm 65 gr. HP (3 Shots) • Remington 9mm 101 gr. Plated Frangible Disintegrator (3 Shots) • Spike Instrument @ Protection Level 3 for E1 Strike/E2 Overstrike (3 Drops) • P1 Edged Blade @ Protection Level 3 for E1 Strike/E2 Strike/E2 Overstrike (3 Drops) • S1 Edged Blade @ Protection Level 3 for E1 Strike/E2 Overstrike (3 Drops)
	5" x 8" (12.7cm x 20.3cm)	0.81 lbs. (0.37 kg)				
	7" x 9" (17.7cm x 22.9cm)	1.23 lbs. (0.56 kg)		Single/Shooters		
	10" x 12" (25.4cm x 30.5cm)	2.0 lbs. (0.91 kg)				
IMPAC-RT Rifle Threats	5" X 7" (12.7cm x 17.7cm)	1.15 lb. (0.5 kg)	1.2 in. (3.0 cm)	Single/Rectangle	Polyethylene	<ul style="list-style-type: none"> • 7.62 mm x 51 mm, 147 gr., FMJ [NATO][M80] (2 Shots) • 7.62 mm x 39 mm, 123 gr., MSC (2 Shots) • .22 Cal. 17gr. FSP Fragmentation • .30 Cal. 44gr. FSP Fragmentation
	5" X 8" (12.7cm x 20.3cm)	1.25 lb. (0.6 kg)				
	7" X 9" (17.7cm x 22.9cm)	2.0 lb. (0.9 kg)				
IMPAC-RT Plus Rifle Threats	5.375" x 8.375" (13.6cm x 21.2cm)	2.75 lb. (1.3 kg)	0.56 in. (1.4 cm)	Flat/Rectangle	Steel/Fiberglass/ Spall Wrap	<ul style="list-style-type: none"> • 7.62 mm x 51 mm, 147 gr., FMJ [NATO][M80] (1 Shot) • 7.62 mm x 39 mm, 123 gr., MSC (2 Shots) • 5.56 mm x 45 mm, 55gr. M193 (3 Shots) • 5.56 mm x 45 mm, 62gr. M855 [SS109] (3 Shots)
	5.375" x 8.375" (13.6cm x 21.2cm)	3.1 lb. (1.4 kg)				
	7.375" x 9.375" (18.7cm x 23.8cm)	4.65 lb. (2.1 kg)		Flat/Shooters		
	10.375" x 12.375" (26.3cm x 31.4cm)	7.25 lb. (3.3 kg)		Flat/Rectangle		
	10.375" x 12.375" (26.3cm x 31.4cm)	8.2 ls. (3.7 kg)				

CONCEALABLE ARMOR

TACTICAL ARMOR

COMMUNICATIONS

DUTY GEAR/HOLSTERS

PROTECTIVE GEAR

ACCESSORIES

FIREARMS

LESS LETHAL

PERFORMANCE APPAREL

SURVIVABILITY SYSTEMS

FORENSICS

ARMOR SYSTEMS

TRAINING ACADEMY

Ballistic Helmets

THE PROTECH® Delta™ line of ballistic helmets set the industry standard for ergonomic comfort, superb ballistic performance and innovative technologies. Our broad product range, including suspension systems and accessories, allows users to choose the helmet configuration that's precisely right for the mission at hand.



All helmets and corresponding accessories are offered in Black, Foliage Green, Coyote Brown and Tactical Green.

COLORS



KHAKI AVAILABLE ON DELTA 4 AND PASGT MODELS

DX, D5, D6 & D4 MODELS AVAILABLE IN FULL-, MID- AND HIGH-CUT

Available in boltless and bolted configurations



FULL-CUT



MID-CUT



HIGH-CUT



SHOWN WITH OPTIONAL ACCESSORIES

DELTA™ X

An ultra-lightweight ballistic helmet designed for 9mm protection and ultimate comfort

- Tested against NIJ 0106.01 protocol, modified to address type IIIA 9mm round and velocity
- 17 gr. V50 ≥ 2400 ft/s (731 m/s)
- Warrior/ACH [brimless] style: Full-, Mid- and High-cut
- 40% lighter than traditional ACH helmets and comprised of polyethylene and other fibers in a matrix composite
- Highest fragmentation performance and lightest IIIA 9mm FMJ helmet on the market

Delta X Ballistic Helmet	Full-Cut	Mid-Cut	High-Cut
Finished Large Shell Weight (approx.) (Suspension not included)	1.47 lbs. (0.67 kg)	1.37 lbs. (0.62 kg)	1.26 lbs. (0.57 kg)
Available Retentions:	Team Wendy® CAM Fit™ & EPIC Air™		



SHOWN WITH OPTIONAL ACCESSORIES

DELTA™ 5

A lightweight ballistic helmet designed for your frontline and special forces needs

- Tested against NIJ 0106.01 protocol, modified to address type IIIA rounds and velocities, 9mm & .44 Magnum
- 17 gr. V50 ≥ 2400 ft/s (731 m/s)
- Warrior/ACH [brimless] style: Full-, Mid-, High-cut
- 30% lighter than traditional ACH helmets and comprised of polyethylene and other fibers in a matrix composite

Delta 5 Ballistic Helmet	Full-Cut	Mid-Cut	High-Cut
Finished Large Shell Weight (approx.) (Suspension not included)	1.87 lbs. (0.85 kg)	1.74 lbs. (0.79 kg)	1.60 lbs. (0.53 kg)
Bolted Available Retentions:	Team Wendy®, R2S with Mesh, and R2S with Padding		
Boltless Available Retentions:	Team Wendy®		

NEW



SHOWN WITH OPTIONAL ACCESSORIES

DELTA™ 6

- Tested against NIJ 0106.01 protocol, modified to address Type III rounds and velocities, 7.62 x 51 mm 147gr. FMJ (M80)
- 17 gr. V50 ≥ 3000 ft/s (914 m/s)
- Warrior/ACH [brimless] style: Full-, Mid-, High-cut

Delta 6 Ballistic Helmet	Full-Cut	Mid-Cut	High-Cut
Finished Large Shell Weight	3.3 lbs. (1.5 kg)	3.1 lbs. (1.4 kg)	2.85 lbs. (1.3 kg)
Available Retentions:	R2S with Mesh, R2S with Padding, Team Wendy, 4-point with mesh, 4-point with padding		



SHOWN WITH OPTIONAL ACCESSORIES

DELTA™ 4

The patriarch ACH/warrior style ballistic helmet offering trusted and tested protection and comfort

- Tested against NIJ 0106.01 protocol, modified to address type IIIA rounds and velocities, 9mm and .44 Magnum
- 17 gr. V50 ≥ 2058 ft/s (627 m/s)
- Warrior/ACH [brimless] style: Full-, Mid-, High-cut

Delta 4 Ballistic Helmet	Full-Cut	Mid-Cut	High-Cut
Finished Large Shell Weight (approx.) (Suspension not included)	2.50 lbs. (1.13 kg)	2.35 lbs. (1.07 kg)	2.15 lbs. (0.98 kg)
Available Retentions:	Team Wendy®, R2S with Mesh, R2S with Padding, 4-Point with Mesh and 4-Point with Padding		

PASGT

Full coverage ballistic helmet for Personnel Armor System Ground Troops

- Tested against NIJ 0106.01 protocol, modified to address type IIIA rounds and velocities, 9mm & .44 Magnum
- 17 gr. V50 ≥ 2058 ft/s (627 m/s)
- Personnel Armor System Ground Troops design – Full-cut with brim



PASGT Ballistic Helmet	Small-Medium	Large-X-Large	Jumbo
Finished Large Shell Weight (approx.) (Suspension not included)	2.80 lbs. (1.27kg)	3.0 lbs. (1.36 kg)	3.5 lbs. (1.58 kg)
Bolted Available Retentions:	R2S with Mesh, R2S with Padding, 4-Point with Mesh and 4-Point with Padding		
Boltless Available Retentions:	R2S with Padding and 4-Point with Padding		



PROTECH® Tactical is proud to partner with companies driven by the same passion to outfit users in the industry's highest quality and most cutting-edge technologies and products. Our partnership with Team Wendy® allows for our Delta™ line of helmets to be outfitted in the lightest and most innovative retention and suspension systems currently on the market.

TEAM WENDY® EPIC AIR™ SUSPENSION

- EPIC Air takes helmet liner systems to a whole new level with lightweight features, ultimate comfort design and blunt trauma protection
- Zorbium™ impact liner features Milspec moisture wicking and loop fabric with anti-microbial comfort pads
- Air channels allow for air flow and temperature control
- Exceeds ACH blunt impact requirements (AR/PD 10-02)



TEAM WENDY® CAM FIT™ RETENTION

- CAM Fit is the most efficient yet durable retention system available, based on a dial ratchet mechanism for quick and secure placement
- CAM-lock™ sliders allow for one-handed adjustability
- Boa® Closure system stabilizes helmet weight by distributing a light, even pressure around the head
- Adjustment straps and chin cup designed for a close, comfortable fit to the wearer's face



R2S™ SYSTEM PROTECH R2S RATCHET WITH PADDING OR MESH CROWN SUSPENSION SYSTEM

- PROTECH's trusted ratchet system that features easy adjustment and a durable hold
- Enhanced security and customizable fit for any head size
- 2" diameter ratchet dial at nape for easy adjustment
- Fas-Trac® components allow for effortless tightening while creating resistance to prevent loosening during use



PADDING SUSPENSION SYSTEM

A traditional padding suspension available in Non-FAT or Milspec, 8-pad configuration for a more customized fit



MESH CROWN SUSPENSION SYSTEM

Our patriarch suspension featuring a 4-point height-adjustable, floating mesh crown component with chin strap



NEW

FOXFURY® HHC TACTICAL LIGHT

- Weight – 4.4 oz
- Battery life: 4-24 hours
- 4 high-powered LED colors
- Power
 - White Light: 10-82 Lumens
 - Red/Blue Lights: 10-38 Lumens
 - Infrared: 25-110 mW
- Versatile design with multiple helmet mounting options
- AA battery operated
- Operating temperature: 14°F to 300°F
- 24-month warranty
- Fire, water, and impact resistant

Helmet not included

Helmet Accessories

CONCEALABLE ARMOR
TACTICAL ARMOR
COMMUNICATIONS
DUTY GEAR/HOLSTERS
PROTECTIVE GEAR
ACCESSORIES
FIREARMS
LESS LETHAL
PERFORMANCE APPAREL
SURVIVABILITY SYSTEMS
FORENSICS
ARMOR SYSTEMS
TRAINING ACADEMY



DK6-H.150 NON-BALLISTIC FACE SHIELD

- NIJ 0104.02 Riot Face Shield
- Polycarbonate lens – hardened and scratch resistant
- Molded 1" brim provides clearance for various gas masks
- Compatible on full- & mid-cut helmets
- Dual liquid barrier
- Interchangeable locking mechanism featuring one-hand release
- Dual retention locks located on both sides of the band to hook to the helmet shell at the base of the shell's ear mold. Adjusts to full or mid-cut cuffs



DK7-X.250AF-RC NON-BALLISTIC FACE SHIELD

- NIJ 0104.02 Riot Face Shield
- Polycarbonate lens – hardened and scratch resistant
- Easily installed onto Picatinny rail sets by rail adapters that slide, adjust and attach to desired location
- Adjustable lens clearance is compatible with helmets with accessories ie. shrouds
- Compatible on full-, mid- and high-cut helmets
- Interchangeable locking mechanism featuring one-hand release
- Weight: 1.0 lbs
- Thinness: 0.150"



BALLISTIC FACE SHIELDS

PROTECH® Tactical ballistic face shields are available for Full- and Mid-cut helmets. The face shields are easily secured to the helmet using a 360° band fastening system.

- Manufactured of polycarbonate/acrylic laminate
- Curved design offers complete facial protection from the helmet brim to below the chin area
- Unique band-fastening system permits quick attachment or detachment and eliminates drilling that could affect ballistic integrity

BALLISTIC FACE SHIELD RAIL MOUNT

- For attachment of ballistic face shield to all Safariland helmets equipped with industry standard side rails and accessories
- Enhances speed of full-, mid- and high-cut attachment and detachment of all models of ballistic face shields
- Compatible on full, mid, and high cut helmets
- Easily deployed with one hand from stowed to deployed position with locking mechanism

IMAGE NOT SHOWN

	702L	702M	702MT
Material	Polycarbonate/acrylic laminate	Polycarbonate/acrylic laminate	Polycarbonate/acrylic laminate
Single/Multi-Hit	Single (9mm FMJ 124 gr.)	Multiple (9mm FMJ 124 gr.)	Multiple (9mm FMJ 124 gr., .44 Mag 240 gr. & 7.62 x 25mm Tokarev)
Size	6" x 15" (15.24cm x 38.10cm)	6" x 15" (15.24cm x 38.10cm)	6" x 15" (15.24cm x 38.10cm)
Weight (Approx.)	2.3 lbs (1.04kg)	2.5 lbs. (1.13kg)	2.9 lbs. (1.31 kg)



Shown with optional bungees

NVG SHROUD

- Lightweight and low-profile aerospace grade metal and carbon fiber
- Designed for compatibility and solid mounting for NVG mounts
- Three hole standard pattern
- Available colors: Black, Tactical Green, Coyote Brown and Foliage Green



Shown with TCI Liberator II Communications System

SIDE RAIL SET

- Industry standard side helmet attachment system
- Open architecture design allows for a multitude of headborne accessory attachments
- Optional bungee accessories available
- Comes with hardware, (2) Wing-Loc adapters and (2) Picatinny adapters
- Available colors: Black, Tactical Green, Foliage Green and Coyote Brown

Ballistic Shields

X SERIES

Made in the **USA**

X SERIES LIGHTWEIGHT SHIELDS

- Introducing the newest in ballistic shields – the X Series comprised of the Mighty Mite X, Defender X, Entry I X, Entry II X and Entry I FR X
- Patent pending lens cap design, never before seen in the industry – a boltless, ballistic lens cap is molded into the body of the shield ballistics eliminating an exposed outer seam and maintaining overall ballistic integrity
- Available in 5 best-selling NIJ 0108.01 Type IIIA shield configurations
- Lightest Type IIIA handgun shields available



MIGHTY MITE X

ENTRY I FR X

SHOWN WITH OPTIONAL TAKER B50 LIGHT SYSTEM

PROTECH® X Series (NIJ 0108.01 Type IIIA)
9mm, 124 gr. FMJ – 5 shots / .44 Magnum, 240 gr. LSWCGC – 5 shots

Product	Model #	Size (approx.)	Ballistic Coverage (approx.)	Weight (approx.)	Areal Density (approx.)	Armor Materials / Construction (Shield Body)	Viewport / Viewport Size	Armor Materials / Construction (Viewport)	Special Threat Testing (Independent NIJ Laboratory)
Mighty Mite X	1630X	18" x 30" (45.72cm x 76.2cm)	514 in ² (3316cm ²)	11 lbs. (4.9 kg)	1 lb./ft ² (4.88kg/m ²)	Polyethylene	Yes/ 7"x10" Triangular (17.8cm x 25.4cm)	Acrylic / Polycarbonate	<ul style="list-style-type: none"> • Tokarev 7.62 x 25mm, 85 gr. FMJ [steel jacket] • 5.7 x 28mm, 28 gr. SS195/HP • 5.7 x 28mm, 40 gr. SS197 Blue Tip • Win. Ranger 9mm, 127 gr. +P+SXT • .357 Sig, 125 gr. TMJ • .22-Cal. FSP, 17 gr. fragmentation • .44-Mag, 240 gr. SJHP
Defender X	1934X	20" x 34" (50.8cm x 86.36cm)	625 in ² (4032cm ²)	11.7 lbs. (5.3 kg)					
Entry I X	2237X	24" x 36" (60.96cm x 91.44cm)	733 in ² (4729cm ²)	13.0 lbs. (5.9 kg)					
Entry II X	2448BX	24" x 48" (60.96cm x 121.92cm)	1102 in ² (7109cm ²)	16.3 lbs. (7.4 kg)					
Entry I FR X	2237 FR X	24" x 36" (60cm x 91cm)	683 in ² (4406cm ²)	12.5 lbs. (5.7 kg)					

NEW

HI-VIZ SHIELD

- Transparent Type IIIA handgun shield in three variations
- Provides protection to the head, neck, and upper chest area
- Ambidextrous horizontal grips
- Can be used with Foxfury® Taker R40 Riot Shield Light (purchased separately)



FRONT VIEW

HI-VIZ SHIELD



BACK VIEW



FOXFURY® TAKER R40 SHIELD LIGHT

FOR USE WITH HI-VIZ SHIELD (purchased separately)

PROTECH® HI-VIZ Shield (NIJ 0108.01 Type IIIA)
9mm, 124 gr. FMJ – 5 Shots / .44 Magnum, 240 gr. LSWCGC – 5 Shots

Product	Model #	Size (approx.)	Ballistic Coverage (approx.)	Weight (approx.)	Areal Density (approx.)	Armor Materials / Construction (Shield Body)	Special Threat Testing (Independent NIJ Laboratory)
HI-VIZ	1224	12" x 24"	269 in ² (1735cm ²)	15.3 lbs. (6.9kg)	4 lbs/ft ²	Polycarbonate	N/A
	1224T	12" x 24"	229 in ² (1477cm ²)	13.2 lbs. (6.0kg)	4 lbs/ft ²		
	924	9" x 24"	226 in ² (1451cm ²)	13.0 lbs. (5.9kg)	4 lbs/ft ²		

BODY BUNKER SERIES



PROTECH® Body Bunker® Shields (NIJ 0108.01 Type IIIA)
9mm, 124 gr. FMJ - 5 Shots / .44 Magnum, 240 gr. LSWCGC - 5 Shots

Product	Model #	Size (approx.)	Ballistic Coverage (approx.)	Weight (approx.)	Areal Density (approx.)	Armor Materials / Construction (Shield Body)	Viewport / Viewport Size	Armor Materials / Construction (Viewport)	Special Threat Testing (Independent NIJ Laboratory)
Body Bunker (24x36)	2436S	24" x 36" (60.96cm x 91.44cm)	864 in ² (5574.18cm ²)	21 lbs. (9.5kg)	1 lb./ft ² (4.88kg/m ²)	Polyethylene	Yes / 4" x 16" (10.16cm x 41cm)	Acrylic / Polycarbonate	<ul style="list-style-type: none"> • Tokarev 7.62x25mm 85 gr. FMJ [steel jacket] (5 Shots) • 5.7x28mm 28 gr. SS195/HP (5 Shots) • 5.7x28mm 40 gr. SS197/Blue Tip (5 Shots) • WIN. Ranger 9mm 127 gr. +P+ SXT (5 Shots) • .357 SIG 125 gr. TMJ (5 Shots) [Testing completed on Mighty Mite] • .22 Cal. FSP 17 gr. Fragmentation • .44 Mag 240 gr. S&JHP (5 Shots)
Body Bunker (31x48)	3148S	31" x 48" (78.74cm x 121.92cm)	1488 in ² (9599.98cm ²)	31 lbs. (14.1kg)					
Body Bunker Breacher (31x48)	3148SB	31" x 48" (78.74cm x 121.92cm)	1488 in ² (9599.98cm ²)	32 lbs. (14.5kg)					

TSI SERIES



PROTECH® TSI Shields (NIJ 0108.01 Type IIIA)
9mm, 124 gr. FMJ - 5 Shots / .44 Magnum, 240 gr. LSWCGC - 5 Shots

Product	Model #	Size (approx.)	Ballistic Coverage (approx.)	Weight (approx.)	Areal Density (approx.)	Armor Materials / Construction (Shield Body)	Viewport / Viewport Size	Armor Materials / Construction (Viewport)	Special Threat Testing (Independent NIJ Laboratory)
TSI 1	2034I	20" x 34" (50.8cm x 86.36cm)	680 in ² (4387.1cm ²)	15 lbs. (6.8kg)	1.5 lbs/ft ² (7.32kg/m ²)	Aramid	Yes / 4" x 10" (10.16cm x 25.4cm)	Acrylic / Polycarbonate	<ul style="list-style-type: none"> • .357 Sig 125 gr. TMJ (5 Shots) • 9mm 127 gr. +P+ SXT (5 Shots) • 5.7x28mm 40 gr. SS197/Blue Tip (5 Shots)
TSI 2	2436I	24" x 36" (60.96cm x 91.44cm)	864 in ² (5574cm ²)	16 lbs. (7.26kg)	1.5 lbs/ft ² (7.32kg/m ²)				
TSI 3	2048I	20" x 48" (50.8cm x 121.92cm)	960 in ² (6193.5cm ²)	16.5 lbs. (7.48kg)	1.5 lbs/ft ² (7.32kg/m ²)				

CONCEALABLE ARMOR | TACTICAL ARMOR | COMMUNICATIONS | DUTY GEAR/HOLSTERS | PROTECTIVE GEAR | ACCESSORIES | FIREARMS | LESS LETHAL | PERFORMANCE APPAREL | SURVIVABILITY SYSTEMS | FORENSICS | ARMOR SYSTEMS | TRAINING ACADEMY

Ballistic Shields

ENTRY SERIES



PROTECH® Entry Shields (NIJ 0108.01 Type IIIA)

9mm, 124 gr., FMJ - 5 Shots / .44 Magnum, 240 gr. LSWCGC - 5 Shots

Product	Model #	Size (approx.)	Ballistic Coverage (approx.)	Weight (approx.)	Areal Density (approx.)	Armor Materials / Construction (Shield Body)	Viewport / Viewport Size	Armor Materials / Construction (Viewport)	Special Threat Testing (Independent NIJ Laboratory)
Mighty Mite	1630	18" x 30" (45.72cm x 76.2cm)	540 in ² (3484cm ²)	14 lbs. (6.35kg)	1 lb./ft ² (4.88kg/m ²)	Polyethylene	Yes / 4" x 10" (10.16cm x 25.4cm)	Acrylic / Polycarbonate	<ul style="list-style-type: none"> • Tokarev 7.62x25mm 85 gr. FMJ [steel jacket] (5 Shots) • 5.7x28mm 28 gr. SS195/HP (5 Shots) • 5.7x28mm 40 gr. SS197/Blue Tip (5 Shots) • WIN. Ranger 9mm 127 gr. +P+ SXT (5 Shots) • .357 SIG 125 gr. TMJ (5 Shots) • .22 Cal. FSP 17 gr. Fragmentation • .44 Mag 240 gr. SJHP (5 Shots)
Defender	1934	20" x 34" (50.8cm x 86.36cm)	680 in ² (4387.1cm ²)	16 lbs. (7.25kg)			Yes / 4" x 16" (10.16cm x 41cm)		
Entry I	2237	24" x 36" (60.96cm x 91.44cm)	864 in ² (5574.2cm ²)	21 lbs. (9.5kg)			Yes / 4" x 16" (10.16cm x 41cm)		
Entry II	2448B	24" x 48" (60.96cm x 121.92cm)	1152 in ² (7432.2cm ²)	24 lbs. (10.89kg)			Yes / 4" x 16" (10.16cm x 41cm)		
Entry 1 FR (First Responder)	2237 MUST	24" X 36" (60cm x 91cm)	864 in ² (5574.2cm ²)	16.75 lbs. (7.8 kg)			4" X 10" (10.16cm x 25cm)		

INTRUDER SERIES



PROTECH® Intruder™ Shields (NIJ 0108.01 Type IIIA)

9mm, 124 gr., FMJ - 5 Shots / .44 Magnum, 240 gr. LSWCGC - 5 Shots

Product	Model #	Size (approx.)	Ballistic Coverage (approx.)	Weight (approx.)	Areal Density (approx.)	Armor Materials / Construction (Shield Body)	Viewport / Viewport Size	Armor Materials / Construction (Viewport)	Special Threat Testing (Independent NIJ Laboratory)
Intruder G2 (w/ LED)	2035G2	20" x 34" (50.8cm x 86.36cm)	670 in ² (4322.5.1cm ²)	21 lbs. (9.5kg)	1 lb./ft ² (4.88kg/m ²)	Polyethylene	Yes / 6.75" x 15.5" (17.2cm x 39.37cm) (at widest points)	Acrylic / Polycarbonate	<ul style="list-style-type: none"> • Tokarev 7.62x25mm 85 gr. FMJ [steel jacket] (5 Shots) • 5.7x28mm 40 gr. SS197/Blue Tip (5 Shots) • WIN. Ranger 9mm 127 gr. +P+ SXT (5 Shots) • .357 SIG 125 gr. TMJ (5 Shots) • .44 Mag 240 gr. SJHP (5 Shots)
Intruder G2 (no lights)	2035G2	20" x 34" (50.8cm x 86.36cm)		21 lbs. (9.5kg)			Yes / 6.75" x 15.5" (17.2cm x 39.37cm) (at widest points)		
Intruder (w/ LED)	2035LED	20" x 34" (50.8cm x 86.36cm)		20 lbs. (9.1kg)			Yes / 4" x 16.75" (10.16cm x 42.55cm)		
Intruder (w/ HIL)	2035WL	20" x 34" (50.8cm x 86.36cm)		21 lbs. (9.5kg)			Yes / 4" x 16.75" (10.16cm x 42.55cm)		
Intruder (no lights)	2035W	20" x 34" (50.8cm x 86.36cm)		16.5 lbs. (7.5kg)			Yes / 4" x 16.75" (10.16cm x 42.55cm)		

FIRST RESPONDER SERIES

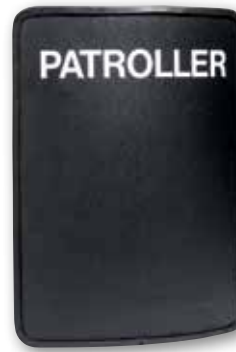

PATROLLER™



PATROLLER™ FR

PROTECH® First Responder Shields (NIJ 0108.01 Type IIIA) 9mm, 124 gr. FMJ - 5 Shots / .44 Magnum, 240 gr. LSWCGC - 5 Shots									
Product	Model #	Size (approx.)	Ballistic Coverage (approx.)	Weight (approx.)	Areal Density (approx.)	Armor Materials / Construction (Shield Body)	Viewport / Viewport Size	Armor Materials / Construction (Viewport)	Special Threat Testing (Independent NIJ Laboratory)
Patroller	2418	18" x 24" (45.72 x 60.96cm)	432 in ² (2789.09cm ²)	8.5 lbs. (3.86kg)	1 lb./ft ² (4.88kg/m ²)	Polyethylene	N/A	N/A	<ul style="list-style-type: none"> • Tokarev 7.62x25mm 85 gr. FMJ [steel jacket] (5 Shots) • 5.7x28mm 28 gr. SS195/HP (5 Shots) • 5.7x28mm 40 gr. SS197/Blue Tip (5 Shots) • WIN. Ranger 9mm 127 gr. +P+ SXT (5 Shots) • .357 SIG 125 gr. TMJ (5 Shots) • .44 Mag 240 gr. S.JHP (5 Shots) • .22 Cal. FSP 17 gr. Fragmentation
Patroller FR (First Responder)	2231NV	22" x 31" (55.8cm x 78.7cm)	682 in ² (4399.9cm ²)	9.6 lbs. (4.4kg)					



STRIKE SHIELD



BARRIER BLANKET



PROTECH® Ballistic Type IIIA and/or Fragmentation Barrier Blankets (NIJ 0108.01 Type IIIA and/or MIL-STD-662F) 9mm, 124 gr. FMJ - 5 Shots / .44 Magnum, 240 gr. LSWCGC - 5 Shots and/or 2 / 4 / 16 / 64 gr. RCC (Round Circular Cylinder) V50 BL(P)									
Product	Model #	Size (approx.)	Ballistic Coverage (approx.)	Weight (approx.)	Areal Density (approx.)	Thickness (Approx.)	Armor Materials / Construction	Outer Cover Material	Special Threat Testing (Independent NIJ Laboratory)
Strike Shield	SS2028	20" x 28" (50.8cm x 71.1cm)	560 in ² (3612.9cm ²)	10.5 lbs. (4.5kg)	2 lb/ft ² (9.8kg/m ²)	.430 in. (1.1cm)	Aramid	1000-denier Cordura® nylon	<ul style="list-style-type: none"> • 2 gr. RCC (V50 avg. - 2879 fps / 878 mps) • 4 gr. RCC (V50 avg. - 2522 fps / 769 mps) • 16 gr. RCC (V50 avg. - 2064 fps / 629 mps) • 64 gr. RCC (V50 avg. - 1737 fps / 529 mps)
NEW MODEL	SX2028	20" x 28" (50.8cm x 71.1cm)	560 in ² (3612cm ²)	6 lbs. (2.7kg)	0.86 lb/ft ² 4.19 kg/m ²	.4 in. (1.0cm)	Polyethylene		<ul style="list-style-type: none"> • 2 gr. RCC (V50 avg. - 3054 fps / 930 mps) • 4 gr. RCC (V50 avg. - 3054 fps / 930 mps) • 16 gr. RCC (V50 avg. - 2296 fps / 700 mps) • 64 gr. RCC (V50 avg. - 1789 fps / 545 mps)
Ballistic Barrier Blanket IIIA	3910	4' x 6' (1.2 m x 1.8 m)			2 lb/ft ² (9.8kg/m ²)	.430 in. (1.1cm)	Aramid		<ul style="list-style-type: none"> • 2 gr. RCC (V50 avg. - 2879 fps / 878 mps) • 4 gr. RCC (V50 avg. - 2697 fps / 822 mps) • 16 gr. RCC (V50 avg. - 2296 fps / 700 mps) • 64 gr. RCC (V50 avg. - 1737 fps / 529 mps)
Fragmentation Barrier Blanket	3909	4' x 6' (1.2 m x 1.8 m)	24 ft ² (2.2 m ²)	35 lbs. (15.9kg)	1.46 lb/ft ² (7.1kg/m ²)	.300 in. (0.8cm)			<ul style="list-style-type: none"> • 2 gr. RCC (V50 avg. - 2560 fps / 780 mps) • 4 gr. RCC (V50 avg. - 2190 fps / 668 mps) • 16 gr. RCC (V50 avg. - 1817 fps / 1817 mps) • 64 gr. RCC (V50 avg. - 1495 fps / 456 mps)



NATO AND ASSAULT SERIES



**PROTECH® NATO Shields (NIJ 0108.01 Type III)
7.62mm x 51mm, 147 gr., FMJ (NATO) (M80 Military Designation) - 5 Shots**

Product	Model #	Size (approx.)	Ballistic Coverage (approx.)	Weight (approx.)	Areal Density (approx.)	Armor Materials / Construction (Shield Body)	Viewport / Viewport Size	Armor Materials / Construction (Viewport)	Special Threat Testing (Independent NIJ Laboratory)
NATO 1 Enhanced	1632P	16" x 32" (43.18cm x 81.3cm)	530 in ² (3419.3 cm ²)	28 lbs. (12.7kg)	4 lbs/ft ² (19.53kg/m ²)	Polyethylene	Yes / 2" x 10" (5.08cm x 25.4cm)	Ballistic Glass / Acrylic	<ul style="list-style-type: none"> • 7.62mm x 39mm, 123 gr., MSC • .22 Cal. 17gr. FSP Fragmentation • .30 Cal. 44gr. FSP Fragmentation • 5.56 x 45 mm, 55 gr. M193
NATO 2 Enhanced	1936P	20" x 34" (50.8cm x 86.36cm)	680 in ² (4387.09cm ²)	34 lbs. (15.4kg)	4 lbs/ft ² (19.53kg/m ²)		Yes / 2" x 10" (5.08cm x 25.4cm)		
NATO 3 Enhanced	2448P	26" x 48" (66.04cm x 121.92cm)	1248 in ² (8051.60cm ²)	81 lbs. (36.7kg)	6 lb/ft ² (29.29kg/m ²)		Yes / 4" x 16" (10.16cm x 41cm)		
NATO SS	2032	20" X 32" (50.8cm x 81cm)	640 in ² (4131 cm ²)	42 lbs. (19 kg)	5 lbs./ft ² (24.41 kg/m ²)	Ceramic/ Polyethylene	Yes / 4" x 10" (10.16cm x 25.4cm)	<ul style="list-style-type: none"> • 7.62 x 39mm, 123 gr. MSC • .22 Cal, 17 gr. FSP • .30 Cal, 44 gr. FSP • 5.56 x 45mm, 55 gr. M193 • 5.56 x 45mm, Tactical Bonded Projectile • 5.56 x 45mm, M855 • 7.62 x 39mm, PS Ball Projectile 	

**PROTECH® Assault Shields (NIJ 0108.01 Type III)
7.62mm x 51mm, 147 gr., FMJ (NATO) (M80 Military Designation) - 5 Shots**

Product	Model #	Size (approx.)	Ballistic Coverage (approx.)	Weight (approx.)	Areal Density (approx.)	Armor Materials / Construction (Shield Body)	Viewport / Viewport Size	Armor Materials / Construction (Viewport)	Special Threat Testing (Independent NIJ Laboratory)
Assault 1	Assault 1	16" x 24" (40.64cm x 60.96)	384 in ² (2477.41cm ²)	12 lbs. (5.4kg)	4 lbs/ft ² (19.53kg/m ²)	Polyethylene	N/A	N/A	<ul style="list-style-type: none"> • 7.62mm x 39mm, 123 gr., MSC (5 Shots) • .22 Cal. 17gr. FSP Fragmentation • .30 Cal. 44gr. FSP Fragmentation
Assault 2	Assault 2	16" x 30" (40.64cm x 76.2cm)	480 in ² (3096.77cm ²)	15 lbs. (6.8kg)					
Assault 3	Assault 3	16" x 39" (40.64cm x 99.06cm)	624 in ² (4025.80cm ²)	19 lbs. (8.6kg)					

Ballistic Shields

PHOENIX SERIES



SHOWN WITH OPTIONAL VIEWPORT PANEL

STANDARD PHOENIX IV

PROTECH® Phoenix IV™ Shield (NIJ 0108.01 Type IV) 7.62mm x 63mm, 166 gr., AP, (30-06) (M2 AP Military Designation) - 5 Shots									
Product	Model #	Size (approx.)	Ballistic Coverage (approx.)	Weight (approx.)	Areal Density (approx.)	Armor Materials / Construction (Shield Body)	Viewport / Viewport Size	Armor Materials / Construction (Viewport)	Special Threat Testing (Independent NIJ Laboratory)
Phoenix IV (Three Panels)	2448V	24" x 48" (60.96cm x 121.92cm)	1152 in ² (7432.24cm ²)	157 lbs. (71.2kg)	11.25 lb/ft ² (54.92kg/m ²)	Ceramic / Polyethylene	N/A	N/A	None
Phoenix IV (Extra Panel)	2448V	17" x 24" (43.18cm x 60.96cm)	384 in ² (2477.41cm ²)	50 lbs. (22.7kg)	11.25 lb/ft ² (54.92kg/m ²)	Ceramic / Polyethylene	N/A	N/A	None
Phoenix IV (Extra Panel w/ Viewport)	2448V	17" x 24" (43.18cm x 60.96cm)	384 in ² (2477.41cm ²)	65 lbs. (29.5kg)	11.25 lb/ft ² (54.92kg/m ²)	Ceramic / Polyethylene	Yes / 6" x 12" (15.24cm x 30.48cm)	Ballistic Glass	None



SHIELD SUPPORT HOOK

Designed to reduce the load-carrying fatigue of extended shield deployment on the user by allocating shield weight onto the attachment.

- Compatible on traditional modular webbing and webless load-bearing platforms
- Easy weave and snap function allows for quick donning and doffing
- Adjustable slide buckle to accommodate users/shield size [up to 36" in length]
- Compatible with all PROTECH® ballistic shields NIJ 0108.01 types III and IIIA –

comes standard with each NATO shield order



FOXFURY® TAKER B50 LIGHT BAR FOR BALLISTIC SHIELDS

The most powerful after-market ballistic shield light available from FoxFury, the Taker B50 is a durable and effective lighting system for tactical operations. Composed of materials such as nylon protective guard, polycarbonate lens and heavy-duty steel braided cable, the Taker B50 is water, impact and fire resistant.

- Weight: 21 oz.
- Battery life: 5-8 hours
- Lithium battery operated (batteries not included)
- Operating temperature: 14°F to 300°F
- 24-month warranty
- Easily installed in-field via hook and loop platform for custom placement or ordered with any PROTECH Tactical shield for standard factory installation *excludes Intruder™ and Intruder™ G2™ models
- 1000 lumens

NEW



FOXFURY® TAKER B10 SHIELD LIGHT

- Weight: 4.7 oz
- Battery life: 1.5 – 10 hours
- 380 lumens
- 1200-foot beam distance
- Lithium battery operated (batteries not included)
- Operating temperature: 14°F to 300°F
- 24-month warranty

NEW



FOXFURY® TAKER B30 SHIELD LIGHT

- Weight: 12.1 oz
- Battery life: 5-8 hours
- 600 lumens
- Low-profile
- Lithium battery operated (batteries not included)
- Operating temperature: 14°F to 300°F
- 24-month warranty

TACTICAL COM

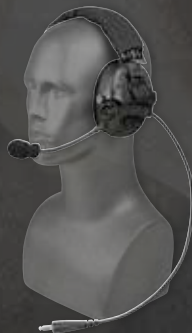
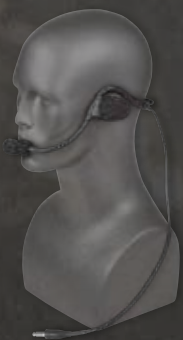

M U N I C A T I O N S



SAFARILAND®



Industry-leading Safariland® communications products are the brand of choice among law enforcement, military and various related markets. Liberator headset systems are in use with all of the branches of the U.S. military, law enforcement agencies and customers in over sixty countries. Celebrating over 20 years, our digital hearing protection technologies meet or exceed all military specifications for hearing conservation while still providing the wearer with excellent situational awareness of their surroundings.





PATENT PENDING

LIBERATOR® IV

ADVANCED SINGLE COMMUNICATIONS HEADSET

- First of its kind multi-mode headset: Electronic Noise Compression and Active Noise Cancellation
- Multiple Push-to-Talk options
- Industry-leading sound localization for maximum situational awareness and threat detection
- Dual Fuel technology which enables the headset to run on either two AAA or one CR123 battery
- First headset with user audio profiles modifiable with simple keystrokes on the headset
- Upgradeable and updateable software by using Near Field Communications (NFC) technology
- Proprietary high-definition speakers and speaker enclosures
- Advanced RF and TDMA PCB protection technology
- Boom microphone featuring noise-cancelling and shielding protection
- Two headset suspension options
- Modular headset suspension – User-adjustable with no tools for either over-the-head, behind-the-head, or helmet rail mounted (rail mounts included)
 - Over-the-head comfort fit – Traditional over-the-head for low-cut helmets
 - Proprietary Earcup design layered with sound barrier technology

COLORS



BLACK

OD GREEN

FDE BROWN



PATENT PENDING

HELMET NOT INCLUDED

LIBERATOR® V

ADVANCED DUAL COMMUNICATIONS HEADSET

- First of its kind multi-mode headset: Electronic Noise Compression and Active Noise Cancellation
- R.4 dual communications Push-to-Talk available - compatible with R.A.C.E.
- Industry-leading sound localization for maximum situational awareness and threat detection
- Dual Fuel technology which enables the headset to run on either two AAA or one CR123 battery
- First headset with user audio profiles modifiable with simple keystrokes on the headset
- Upgradeable and updateable software by using Near Field Communications (NFC) technology
- Proprietary high definition speakers and speaker enclosures
- Advanced RF and TDMA PCB protection technology
- Boom microphone featuring noise-cancelling and shielding protection
- Two headset suspension options
- Modular headset suspension – User-adjustable with no tools for either over-the-head, behind-the-head, or helmet rail mounted (rail mounts included)
 - Over-the-head comfort fit – Traditional over-the-head for low-cut helmets
 - Proprietary Earcup design layered with sound barrier technology

COLORS



BLACK OD GREEN FDE BROWN



LIBERATOR® V WITH R.A.C.E.

RADIO AUDIO CHANNEL ENHANCEMENT MODIFICATION

The Liberator® V dual communications headset with R.A.C.E. allows you to hear audio in both Earcups instead of just one, when only one radio is receiving. When both radios are receiving at the same time, the system reverts back to the traditional dual communications audio environment, with radio audio coming from the corresponding Earcup.

- Improves audio quality for individuals with hearing loss in one ear
- Audio still secure – absolutely no bleed through between radios
- Situational Awareness and Localization Audio still separate from Radio Audio
- Modification available on all new dual comm PTT's, or retrofit to previously purchased PTT's

PATENT PENDING

R.A.C.E.

When both radios are in use, audio received in corresponding Earcup

**RADIO 1 - RIGHT EARCUP
RADIO 2 - LEFT EARCUP**



When only one radio is in use, audio received in both Earcups

**RADIO 1 - RIGHT & LEFT EARCUPS
OR
RADIO 2 - RIGHT & LEFT EARCUPS**



HELMET MOUNTING SOLUTIONS

HELMET RAIL AND UNIVERSAL HEADSET MOUNTING ADAPTORS

- Compatibility with Ops Core type, Team Wendy type, and Crye type rails
- Billet Aluminum – more durable than polymer mounts used elsewhere
 - Extended vertical adjustment
 - Uses common Phillips head set screw
 - Non-reflective surface
- Offered with TCI manufactured rail mount
 - Designed to offer more vertical torque support than other mounts
 - Improved long lasting locking ratchet
 - Smoother rotational movement with grip surfaces
 - Non-reflective wire forms
- Can swap between over-the-head suspension and rail helmet mount
- Retrofit service for all existing Liberator II/III's - warranty maintained



Wireless Communications



LIBERATOR® V

TACTICAL WIRELESS MODULE

- Music and cell phone continuous operational time: 8 hrs
- Standby time: 10 days
- Charge time: 1 hr (lithium ion battery)
- Range: 33ft (10 meters)
- Compatible wireless profile: A2DP, AVRCP, HSP, HFP
- Multi-point pairing
- IP67 rated: dust proof and water submersible for up to 30 minutes
- Programmed with voice prompts for calling and power status
- Utilizes standard COTS 3-button wireless interface that includes accepting calls, dropping calls, and cycling music playlists
- Includes Micro-USB charging cable
- Impedance agnostic
- Also available for the Liberator III™ headset

GAS MASK SOLUTIONS

Gas Mask Solutions



MOBILE FORCE FIELD (MFF) KIT

- Connects PTT assemblies directly to a gas mask for clear audio transmissions
- Includes tubeless audio receiver, NIOSH-approved gas mask cable, military-approved connectors, enforced cables and a one-piece, overmolded system for longevity



GAS MASK ADAPTER (GMA)

- An economical and easily operated solution to gas mask connectivity
- Easily converts existing communications systems
- Can be left connected to the end user's gas mask until needed
- No modification to existing gas mask or communications accessories required
- Available in Black



ALPHA PUSH-TO-TALK (APTT)

- Gas mask connectivity comes standard
- Various options available such as cell phone, volume control, and remote PTT functionality
- Includes ambidextrous MOLLE loop-attachable clothing clip
- Utilizes the legacy U94 form factor with more advanced and reliable construction
- Available with 18 in. radio interface cable and 2-pin gas mask receptacle



M.A.S.T.™

MODULAR ANTENNA SYSTEM TACTICAL

- Increase radio antenna efficiency, line-of-sight range, user ergonomics, and to relocate tactical radio antennas
- Version 1: TNC-M to TNC-F
- Version 2: TNC-M to BNC-M with BNC-TNC quick disconnect adaptor available in straight or 90°
- Version 4: SMA-F to SMA-F
- Version 5: (Waterproof IP68) TNC-M tight angle to TNC-F
- Includes cable, M.A.S.T. antenna harness, and MALICE Clip
- Compatible with modular webbing systems
- 24" or 42" high-durability overmolded cable options available
- Compatible with military radios with TNC connections or law enforcement/first responder radios with SMA connections
- Harness available in Black, OD Green, FDE Brown and Foliage Green



M.A.S.T. VERSION 2

**QUICK DISCONNECT VERSION
MILITARY-MBITR/PRC-152/
PRC-154**



**M.A.S.T. VERSION 3
SATCOM VERSION**



M.A.S.T. VERSION 4

**FIXED VERSIONS MOTOROLA XTS,
APX, KENWOOD NX300**



M.A.S.T. VERSION 5

**WATERPROOF, IP68 FIXED
VERSION MILITARY-MBITR/
PRC-152/PRC-154**



M.A.S.T. VERSION DOJ

**INLINE - QUICK DISCONNECT
VERSIONS MOTOROLA XTS,
APX, KENWOOD NX300**



Throat Microphone System

TTMK III™

TACTICAL THROAT MICROPHONE

- Offers the latest in throat conduction microphone technology
- Dual communications; upgradeable with AMC connector for use with TCI "U" series advanced Push-to-Talk (PTT) and accessories
- Well suited for use with gas masks, respirators, and/or use with NBC/WMD/HAZMAT ensembles
- Low-profile, usable with a wide array of protective face shields and ballistic helmets
- Can be worn under clothing for low visibility mission sets
- Includes TCI's PTT, a Soundwaves/FC R3™ Earcoil for crisp and clear receive audio and headset storage bag
- Users can select either our TACT-LITE™ Earmolds or the Sound-Attenuation Ear-Insert as their earpiece
- Supports over 250 different radio interfaces and manufacturers
- Custom configurations on request



LOW-PROFILE HEADSETS

Low-Profile Headsets

TECS

TACTICAL ENFORCEMENT LOW-VISIBILITY MODULAR EARPIECE

- Crystal clear audio delivered to inner-ear using Soundwaves/FC R4 Earcoil and choice of Ear-Insert types
- Noise-canceling/waterproof microphone
- TCI Push-to-Talk (PTT) assembly included
- Supports military or law enforcement/first responder radio systems
- Durable, yet supplied with flexible cables
- PTT compatible with other TCI headset products allowing future augmentation of the system and capabilities



SAS II

SPECIAL AIR SERVICE LOW-VIS

- Crystal clear audio delivered to inner-ear using Soundwaves/FC R4 Earcoil and choice of Ear-Insert types
- Multi-use system for tactical and low-visibility applications
- Noise-canceling/waterproof microphone
- Fixed Push-to-Talk assembly included
- Supports military or law enforcement/first responder radio systems
- Durable, yet supplied with flexible cables





TABC III DUAL COMMUNICATIONS

TACTICAL ASSAULT BONE CONDUCTION HEADSET

- Binaural Dynamic Audio Resonance System "DARS" is our proprietary sound reproduction system that provides pristine audio fidelity that bypasses the ear drum and goes directly to the cochlea through the mandible (jaw bone)
- State-of-the-art, bone-to-bone conduction transducers and noise-canceling boom microphone
- Supports military or law enforcement/first responder radio systems
- TCI Tactical Push-to-Talk (PTT) included, dual communications version upon request
- Lightweight, adjustable headset fits under ballistic helmets or other non-ballistic rigid or soft head gear
- Designed to leave user's ears unobstructed for natural situational awareness and peripheral hearing



HEARING PROTECTION

LIBERATOR® HP

ADVANCED HEARING PROTECTION

- First of its kind multi-mode headset: Electronic Noise Compression and Active Noise Cancellation
- Provides enhanced hearing protection in all environments, while advanced sound localization provides maximum situational awareness and threat detection
- Dual Fuel technology which enables the headset to run on either two AAA or one CR123 battery
- 100-300-hour run time (mode dependent)
- Proprietary high definition speakers and speaker enclosures
- Modular headset suspension, user adjustable to be either over-the-head or behind-the-head for maximum comfort
- Proprietary Earcup design layered with sound barrier technology
- Push-to-Talk (PTT) can also be purchased separately for use with system



COLORS





TWO-WIRE PATROL KIT

- Lightweight (less than 2 oz.)
- Quick-detach Hirose connector included
- Cable lengths optimized for threading through suits, uniforms, body armor, and other tactical apparel
- Moisture-inhibiting acoustic tubing can be used for surveillance or as a lightweight replacement for the bulky shoulder-worn speaker microphone handset
- Two ear piece types included: silicone gel tip for partial occlusion and foam tip for full occlusion and comfort
- In-ear tips provide better sound clarity, require lower radio volume, and increase radio battery run-time
- Available for Motorola XTS and APX radios; other radios available upon request



10-2

RECEIVE ONLY KIT

- Earpiece kit provides seamless audio directly from an operator's remote speaker microphone
- Isolated audio for enhanced audio reception in loud noise situations
- Compatible with any remote speaker mic with a 3.5mm non-threaded receptacle
- Allows officer to leave portable radio volume turned on while in the vehicle
- Includes moisture inhibiting acoustic tubing, durable 14" coiled 3.5mm cable, acoustically enhanced audio transducer and three semi-custom Earmolds in various sizes; Small, Medium, Large



CIPS KIT

COVERT IN PLAIN SIGHT KIT

- Provides plainclothes officers a solution to remain covert when communicating via a portable radio
- Allows officers to use a portable radio while wearing earbuds commonly associated with smartphones or MP3 players
- The portable radio is connected to a mini Push-to-Talk (PTT) Sniper Ring, so the officer is able to key the radio and use the microphone in the smartphone headset without any indication to outsiders that a tactical radio is in use
- Lightweight (less than 2oz.)
- Cable lengths optimized for threading through clothing
- Quick detach system to transition to personal electronics
- PTT available in Beige (exclusive to TCI) and Black
- Initially available for Motorola XTS, APX radios and Harris P5300/XG-75; other radios available upon request



NEW



**LIBERATOR® FLASHPOINT™ SYSTEM
FIREFIGHTER SINGLE
COMMUNICATIONS HEADSET**

- First of its kind multi-mode headset with Passive Electronic Noise Compression and Active Noise Cancellation technology that protects hearing, while allowing clear communication in the noisiest environments
- Ambient sound amplification for situational awareness / face-to-face communication
- Noise canceling boom microphone for clear voice transmission in Self Contained Breathing Apparatus (SCBA)
- Extreme temperature durability (500°F for 5 minutes)
- Cut, abrasion, and flame-resistant cable covers
- Universal axial suspension can be worn over-the-head, or behind-the-head to fit under most fire and rescue helmets
- Water spray resistant and submersible up to three (3) feet
- Compatible with all fire helmets
- Compatible with all SCBA
- Third party tested - explosive atmosphere certified, mil-spec certified and certified at 26 dB NRR
- Easily cleaned / decontaminated

SYSTEM INCLUDES LIBERATOR® SPARK™
REMOTE SPEAKER MICROPHONE (RSM)

Fire Communications

NEW



LIBERATOR® SPARK™ **REMOTE SPEAKER MICROPHONE (RSM) / PUSH-TO-TALK**

- Use as a stand-alone RSM, or integrate with a Liberator® II, Liberator® IV, Liberator® Flashpoint headset, as well as communication accessories such as TECS, TTMK III or TABC III
- 3.5mm listen only connector (monaural), compatible with 10-2, or any 3.5mm earbud
- Dual noise canceling microphones for clear transmit at any direction
- Extreme temperature durability (500°F for 5 minutes)
- Cut, abrasion, and flame-resistant cable covers
- Water spray resistant and submersible up to three (3) feet
- Ergonomic design allows ease of use with gloved hands
- Emergency Activation Button (EAB) and Push-to-Talk (PTT) easily activated with gloved hands (for most radios), while protected from accidental activations (available for most radios)
- Easily cleaned / decontaminated

NEW



LIBERATOR® OVERWATCH™ **INCIDENT COMMAND DUAL COMMUNICATIONS HEADSET**

- First of its kind multi-mode headset with Passive Electronic Noise Compression and Active Noise Cancellation technology that protects hearing, while allowing clear communication in the noisiest environments
- Ambient sound amplification for situational awareness / face-to-face communication
- Noise canceling boom microphone for clear voice transmission in Self Contained Breathing Apparatus (SCBA)
- Bifurcated audio allows simultaneous radio message reception in corresponding Earcup; right radio in right ear, left radio in left ear
- Multi-functional dual PTT allows for message transmission to one or both radios at the same time
- Universal axial suspension can be worn over-the-head, or behind-the-head to fit under most fire and rescue helmets
- Water spray resistant and submersible up to three (3) feet
- Compatible with all SCBA and public safety portable radios
- Third party tested - explosive atmosphere certified, mil-spec certified and certified at 26 dB NRR
- Liberator V® Tactical Wireless Module compatible
- Easily cleaned / decontaminated

Optional - Can be configured for extreme temperature durability (500°F for 5 minutes) and with cut, abrasion, and flame-resistant cable covers

SAFARILAN



D D U T Y G E A R



Safariland® holsters and accessories are the overwhelming choice for law enforcement officers and competition shooters around the world. Known for quality, performance and technological advancements in design, new products are continually being developed with the most knowledgeable and experienced users in the industry and field tested by users and our world-renowned Team Safariland shooters to provide you with the best available final product.



MATERIALS

SAFARISEVEN™

- Proprietary DuPont™ nylon blend that is completely non-abrasive to a firearm's finish
- Raised stand-off surfaces inside holster create airspace to easily clear debris and allow an effortless draw
- Impervious to the elements: can be submerged in water for long periods with no loss of structural integrity
- Very high heat and cold tolerances; structurally sound at 300°F and -50°F
- Can be submerged in water indefinitely and still maintain shape and function

SAFARISEVEN COLORS



SAFARILAMINATE™

- Impact-resistant thermoplastic alloy is thermoformed around the holster at close tolerances for an exact fit and the thermal-laminate finish
- Impervious to moisture, bloodborne pathogens, and does not break down like natural materials
- Extremely durable and maintains professional looking appearance for years
- Traditional Leather Look - in Plain, Basketweave, Hi Gloss, and Nylon-Look
- STX finishes available in Plain, Basketweave and Hi Gloss

SAFARILAMINATE & STX TACTICAL COLORS



STX TACTICAL® - exclusive "haircell" finish. Famous for its incredible strength and abrasion resistance, available in several finishes and colors

RETENTION LEVELS & SYSTEMS

Safariland duty holsters are classified by retention level from I to IV. The Safariland system for holster retention testing, developed in the 1980s, is still the only established and uniform set of criteria in the marketplace for strict testing to evaluate the retention level of a duty holster.

This testing system helps officers evaluate and make informed decisions on the type of holster needed for different scenarios and environments. This criterion sets retention levels by the duration of force and the type of action/activity the officer must complete to remove the weapon from the holster. For more information on Safariland retention level guidelines, visit Safariland.com/retention-levels.html



ALS
automatic locking system

The ALS® or Automatic Locking System provides a high level of security without adding thumb breaks, snaps, or levers requiring the use of the trigger finger.

- Intuitive release locks into ejection port and upon the draw, the thumb depresses the lever and releases the weapon
- Hood Guard helps protect the ALS from impact and premature release, especially in an attempted takeaway. Included with all duty and tactical versions



GLS
grip locking system

Much like the ALS® with its intuitive draw, the GLS™ or Grip Locking System, is automatically disengaged when taking a shooting grip

- The GLS retention device is operated by the middle finger, simply obtain a shooting grip to release the mechanism
- Automatically locks weapon in place upon holstering
- Only available on concealment models



SLS
self locking system

The SLS or Self Locking System rotating hood has been tested and proven for many years. Simply push down and rotate forward as you obtain your shooting grip.

- Rotating hood system
- Simply push down and rotate forward as you obtain your shooting grip. To close, pull back on the hood, and the SLS self locks
- Optional Sentry lever increases retention level by one

ALS / SLS
automatic locking system / self locking system

ALS/SLS Combined Retention Systems

- Rotating hood system and ejection port lock operated by the thumb once the SLS is released
- Simply push down and rotate forward as obtain your shooting grip
- Intuitively upon the draw the thumb depresses the lever and releases the weapon

Level III & IV Retention



7360

7TS™ ALS®/SLS MID-RIDE

Level III Retention™

- ALS® (Automatic Locking System) secures weapon once holstered; simple straight up draw once release is deactivated
- SLS (Self Locking System) Rotating Hood
- Level IV Retention™ with optional Sentry installed
- A proprietary nylon blend that is completely non-abrasive to a firearm's finish
- Raised stand-off surfaces in holster's interior creates air space around the weapon allowing dirt and moisture to quickly clear any contact with the firearm
- Very high heat and low cold tolerances; structurally sound from 300° F to -50° F
- Available in SafariSeven™ Plain, Basketweave, Hi Gloss and FDE Brown finishes



7362

HI-RIDE UBL

7365

7TS™ ALS®/SLS WITH LOW-RIDE UBL

- 1.5" (38mm) Belt Drop version



070

SSIII WITH MID-RIDE UBL

Level III Retention™

- Mid-ride belt position and slightly forward grip cant allow for comfortable carry and quick, easy draw
- Top thumb break and middle finger release tab, internal ejection port lock
- Offered for 2.25" (58mm) belt slot only
- Available in Plain Black, Basketweave, Hi Gloss or Nylon Look finishes

0705

LOW-RIDE UBL

- 1.5" (38mm) Belt Drop version



Level III Retention



PATENTED



6360 ALS®/SLS MID-RIDE Level III Retention™

- ALS® (Automatic Locking System) secures weapon once holstered
- SLS (Self Locking System) Rotating Hood
- Level IV Retention™ with optional Sentry installed
- Slim, compact design allows weapon to ride close to body
- Simple straight up draw once all releases are deactivated
- Available in RDS model
- Available in Plain Black, Basketweave, Hi Gloss, Nylon Look, STX or STX Tactical® finishes (all colors)



PATENTED

6365 LOW-RIDE UBL

- 1.5" (38mm) Belt Drop version



PATENTED

6362 HI-RIDE UBL

Level II Retention



6280

**SLS MID-RIDE DUTY
Level II Retention™**

- SLS (Self Locking System) Rotating Hood
- Straight up draw
- Level III Retention™ with optional Sentry installed
- Available in Plain Black, Basketweave, Hi Gloss, Nylon Look, STX or STX Tactical® finishes (all colors)



PATENTED

7280

**SLS MID-RIDE DUTY
Level II Retention™**

- SLS (Self Locking System) Rotating Hood
- Level III Retention™ with optional Sentry installed
- A proprietary nylon blend that is completely non-abrasive to a firearm's finish
- Raised stand-off surfaces in holster's interior creates air space around the weapon allowing dirt and moisture to quickly clear any contact with the firearm
- Very high heat and low cold tolerances; structurally sound from 300° F to -50° F
- Available in SafariSeven™ Plain, Basketweave, Hi Gloss and FDE Brown finishes



6282

HI-RIDE UBL



2955

LOW-RIDE UBL

- 1.5" (38mm) Belt Drop version



PATENTED

7282

HI-RIDE UBL



6285

LOW-RIDE UBL

- 1.5" (38mm) Belt Drop version



PATENT PENDING

295

**MID-RIDE UBL
Level II Retention™**

- Front wraparound thumb break and an internal trigger guard lock for secure weapon retention
- Slightly forward grip cant allows for comfortable carry and quick, easy draw
- Offered in 2" (50mm) or 2.25" (58mm) belt slots
- Available in Plain Black, Basketweave, Hi Gloss or Nylon Look finishes



PATENTED

7285

LOW-RIDE UBL

- 1.5" (38mm) Belt Drop version

Level I Retention



PATENTED

7390
7TS™ALS® MID-RIDE DUTY
Level I Retention™

- ALS® (Automatic Locking System) secures weapon once holstered; simple straight up draw once release is deactivated
- Open-top design without SLS for quick retrieval of weapon
- Optional ALS Guard available for increasing level of security by one to a Level II Retention™
- A proprietary nylon blend that is completely non-abrasive to a firearm's finish
- Raised stand-off surfaces in holster's interior creates air space around the weapon, allowing dirt and moisture to quickly clear any contact with the firearm
- Very high heat and low cold tolerances; structurally sound from 300° F to -50° F
- Available in SafariSeven™ Plain, Basketweave, Hi Gloss and FDE Brown finishes



PATENTED



6390
ALS® MID-RIDE DUTY
Level I Retention™

- ALS® (Automatic Locking System) secures weapon once holstered; simple straight up draw once the release is deactivated
- Optional ALS Guard available for increasing level of security by one to Level II Retention™
- Open-top design without SLS for quick retrieval of weapon
- SafariLaminate™ thermoformed construction protects handgun and sights
- Available in STX finishes
- Available in RDS model



200
TOP GUN MID-RIDE
Level I Retention™

- Features a top draw, mid-ride, straight-drop cant and a thumb break with a one-way directional snap
- Adjustable holster tensioning device easily allows the controlling of friction with the turn of a screw
- Available in Plain Black, Basketweave, Hi Gloss or Nylon Look finishes



PATENTED

7392
HI-RIDE UBL

6392
HI-RIDE UBL



PATENTED

2
HI-RIDE DUTY
Level I Retention™



PATENTED

7395
LOW-RIDE UBL

- 1.5" (38mm) Belt Drop version



PATENTED

6395
LOW-RIDE UBL

- 1.5" (38mm) Belt Drop version



2005
LOW-RIDE UBL

- 1.5" (38mm) Belt Drop version

Electronic Discharge Weapon Holsters

ELECTRONIC DISCHARGE WEAPON HOLSTERS

Safariland® offers a wide array of holster models to address the market expansion in the use of EDWs, or electronic discharge weapons. The Safariland SLS has improved the offerings of the EDW holster from a simple device, holding a weapon in a Retention Level-quality holster.



7520

7TS™ SLS EDW HOLSTER WITH CLIP

Level II Retention™

- SLS (Self Locking System) Rotating Hood
- A proprietary nylon blend that is completely non-abrasive to a cartridge's finish
- Raised stand-off surfaces in holster's interior creates air space around the weapon, allowing dirt and moisture to quickly clear any contact with the cartridge
- Clip-on style belt loop with ability to fit 1.5" (38mm), 1.75" (45mm), 2" (50mm) or 2.25" (58mm); belt clip is user-adjustable for cant angle
- Designed for vertical or cross draw carry
- Closed bottom with drain hole to protect cartridge and officer
- Very high and low cold tolerances; structurally sound from 300°F to -50°F
- Available in SafariSeven™, Plain Black, Basketweave and Hi Gloss
- Now available with ECA cant adapter, for more aggressive cross draw cant



6287

SLS EDW BELT LOOP Level II Retention™

- Rides close to body
- SLS (Self Locking System) Rotating Hood
- Adjustable cant, can be worn strongside or cross draw
- Closed bottom with drain hole to protect cartridge and officer
- SafariLaminate™ construction with suede lining
- Available in Plain Black or STX Tactical® finishes (all colors)



6520

SLS EDW HOLSTER WITH CLIP

Level II Retention™

- SLS (Self Locking System) Rotating Hood
- Clip-on style belt loop with ability to fit 1.5" (38mm), 1.75" (45mm), 2" (50mm) or 2.25" (58mm); belt clip is user-adjustable for cant angle
- Designed for vertical or cross draw carry
- Closed bottom with drain hole to protect cartridge and officer
- SafariLaminate™ construction with suede lining
- Available in Plain Black, Basketweave, Hi Gloss, Nylon Look, STX or STX Tactical® finishes (all colors)
- Now available with ECA cant adapter, for more aggressive cross draw cant



521-CAP

EDW CARTRIDGE ACCESSORY PLATE

- Attaches to the 745BL Belt Clip
- Provides convenient storage area for additional EDW cartridge
- Available for Models 520 & 6520
- Available in Plain Black, Basketweave, Hi Gloss or Nylon Look finishes
- Holster sold separately

Duty Holster Accessories

HOLSTER MOUNTING PLATFORMS

Safariland® offers the broadest line of holsters for law enforcement, so it follows that we would also provide the most extensive line of mounting platforms and accessories for our holsters. These options add versatility, comfort, and convenience as you perform your duties.

UNIVERSAL BELT LOOP

(UBL) STYLES

- Will not pinch or add pressure to hip bone (support ridge removed from the belt shank)
- Locks onto the duty belt with belt slot design, no belt tension screws needed; will not damage top of belt
- Compatible with any holster with the 3-hole pattern



NEW

VERTICAL UNIVERSAL BELT LOOP VUBL

- 3 height adjustment options
- Can be adjusted while holster is on belt
- Passes retention pull test
- Fits 2" or 2.25" width belts

6070UBL-PAD MID-RIDE

6075UBL-PAD LOW-RIDE



- Provides a soft pad between the body and Universal Belt Loop (UBL)
- Helps address comfort issues associated with wearing a duty belt for long periods of time
- Works equally well for both male and female officers

RIDE HEIGHTS FOR VARIOUS BODY STYLES



Mid-rise: standard ride height



Low-rise: drop version 1.5" below waist



Mid-rise with HDA: drop version 2" below waist



6070UBL
2" OR 2.25"
MID-RIDE
UBL



6075UBL
2" OR 2.25"
LOW-RIDE
UBL



6072UBL
2" OR 2.25"
HI-RIDE
UBL



P2201
CONVERTS
2.25" UBL TO A 2"
BELT SLOT



6281HDA
DROPS
HOLSTER
BY 2"



HRA
HI-RIDE
ADAPTER
LIFTS HOLSTER
BY 2"

SPACER KITS

Spacer kits are available to position the holster away from the body to accommodate various body shapes. The kits are designed for use with Safariland 3-hole pattern holsters and tactical accessories.



T-SPACER-KIT

- Positions holster farther away from body for a smooth and comfortable draw
- For use on holsters only



HDA-KIT

- Designed to lower holster by 2" (50mm)
- For use on holsters only, right and left hand specific



OVAL SPACER-KIT

- Positions upper portion of holster farther away from body without spacing the bottom any further, giving an increased "outward" cant



CUSTOMIZED-KIT

- Positions holster farther away from body for a smooth and comfortable draw
- For use with holsters or accessories

Holster Accessories

CONCEALMENT HOLSTER MOUNTING PLATFORMS



**745BL
BELT CLIP**

- 3-hole pattern, allowing interchangeability
- Clips on/off belt without having to remove other accessories on rig
- Durable nylon; passes Level I Retention™ pull test
- Fits belt widths from 1.5" (38mm) to 2.25" (58mm)



**568BL
PADDLE**

- Fits up to 1.75" belt widths
- No belt necessary for use



**565BL
HI-RIDE
BELT LOOP**

- Used on any Safariland® 3-hole pattern holster
- Available in 1.5" or 1.75" belt width



**566BL
BELT LOOP**

- Rides 1" or 2" higher than standard 567BL belt loop
- Fit belt widths up to 1.5" (38mm)



**567BL
BELT LOOP**

- Seven different options available up to 2.25"



**571BL
MICRO PADDLE**

- Fits belt widths from 1.5" (38mm) to 1.75" (45mm)

SLS/ALS ACCESSORIES



SLS (SELF LOCKING SYSTEM)

FITS ALL SLS MODELS



ALS (AUTOMATIC LOCKING SYSTEM)



**6000
SLS HOOD GUARD**

- Features a uniquely designed accessory protection for the SLS holster system
- Will adapt to any SLS holster
- Colors: Black, Tan, Foliage Green



**6001
SLS SENTRY**

- Features a uniquely designed accessory protection for the SLS holster system
- Will adapt to any SLS holster and increase the retention level by one
- Color: Black



**6002
SLS SENTRY & HOOD GUARD**

- Features the Sentry installed into the Hood Guard
- Will adapt to any SLS holster
- Hood Colors: Black, Tan, Foliage Green
- Sentry only available in Black



LOCKED



UNLOCKED

**6006
ALS® GUARD**

- Provides additional security for select ALS® concealment, tactical and duty holsters
- Fits all ALS holsters without SLS rotating hood
- Covers ALS lever to prevent any accidental or unauthorized use
- Can be retrofitted onto existing ALS concealment holsters
- Color: Black

**6007
ALS HOOD GUARD**

- Features a uniquely designed accessory protection for the ALS holster system
- Will adapt to any ALS holster
- Colors: Black, Tan, Foliage Green

**6008
HOOD GUARD
& ALS GUARD**

- Features the ALS guard installed into the hood guard
- Fits all ALS holsters without SLS rotating hood
- Covers ALS lever to prevent any accidental or unauthorized use
- Colors: Black, Tan, Foliage Green (ALS Guard Black only)

Holster Mounting Platforms



Shown: Duty Belt with Single Leg Shroud with 6004-DFA

6004-DFA

DROP FLEX ADAPTER

- Allows user to wear a thigh rig below the hip without shifting weight farther down the leg
- Keeps rig from sliding on belt no keeper needed
- Can be used on belt widths up to 2.25" (58mm)
- For use in conjunction with the 6004-10 Leg Shroud



WITH QLS FORK



WITH 568BL PADDLE



WITH ELS FORK



WITH 745BL BELT CLIP

6004-UFA

UNIVERSAL FLEX ADAPTER

- Allows user to wear a thigh rig below the hip without shifting weight farther down the leg
- Hole pattern on UFA makes connecting to various mounts possible, including the 568BL Paddle, ELS Fork, QLS Fork, or 745BL Belt Clip
- For use in conjunction with 6004-10 Leg Shroud

Duty Belts

DUTY BELTS

All belts available in Black unless otherwise specified, and buckles are offered in a choice of chrome or brass finish



031
D-RING BELT 1.5" (38MM)

- Reinforced instructor-style belt
- Lined with loop material



51
GARRISON WITH SQUARE BUCKLE 1.75" (45MM)

- Full grain leather construction
- Includes removable square chrome or brass buckle



99/999
BUCKLELESS™ REVERSIBLE BELT 1.5" (38MM)

- Loop can be worn on the outside, creating a Buckleless system
- Order 999 for belt without loop lining



992
REVERSIBLE SAFARILAMINATE™ BELT 1.5" (38MM)

- Lined with loop material
- Designed to be worn under duty belts with hook as the foundation of the Safariland® Buckleless™ system
- The 992 is the contour version of the 99



942
CONTOURED BUCKLELESS™ BELT 2" (50MM) OR 2.25" (58MM)

- Tip of belt points to the right side of the officer
- Greater all-day comfort by distributing weight evenly; no sharp edges to dig into hips
- Lined with hook to mate with 99 underbelt
- Features a hidden brass hook closure



87/87V
SAM BROWNE BELT 2.25" (58MM)

- Standard duty belt with a suede lining
- 4-stitch design with free-sliding keeper to hold belt tip in place
- Double-tongued buckle and center belt stud fasten belt firmly around waist
- 87V with hook lining



146/146V
BORDER PATROL WITH BUCKLE 2.25" (58MM)

- Billeted belt design with 1.25" billets and buckle
- The 1.25" (32mm) and 2.25" (58mm) keepers hold the interior and exterior belt tips in place
- 146V version features hook lining



872
CONTOURED BELT 2.25" (58MM)

- 4-stitch design with suede lining and free-sliding keeper to hold belt tip in place
- 2.25" (58mm) duty belt is contoured for proper alignment and greater comfort
- Greater all-day comfort; no sharp edges to dig into hips



875
SAM BROWNE STITCHED EDGE 2.25" (58MM)

- Standard duty belt with a plain border stitch
- Double-tongued buckle and center belt stud fasten belt firmly around waist



4330
PADDED UNDER BELT

- 3" padded belt liner for use with duty or tactical belts
- Padding extends beyond edges of belt to help with weight distribution and remove pinch point
- Anti-bacterial and anti-microbial mesh interior



94/94P
BUCKLELESS™ BELT 2.25" (58MM)

- Features a hidden brass hook and a hook and loop closure on both ends
- Belt is lined with a band of hook and loop and attaches to the lining on the Model 99 or 992, completing the Buckleless system
- 94P without hook and loop



4320
PADDED BELT LINER

- Provides a padded buffer between duty belt and body
- Helps eliminate possible bruising and other comfort issues associated with wearing a duty belt for long periods of time



4325
NYLON BUCKLELESS™ REVERSIBLE BELT 1.5" (38MM)

- Hook and loop closure
- Lined with loop material



DUTY ACCESSORIES

- Durable SafariLaminate™ construction for long-lasting wear
- All accessories are designed to fit 2.25" (58mm) duty belts unless otherwise specified
- Finishes offered: traditional leather look; in Plain, Basketweave or Hi Gloss; STX Tactical® in all colors
- Many Safariland® duty accessories are available with hidden snap closure. Visit safariland.com/safariland
- Snap versions available in Chrome, Brass or Black

NOTE: ITEMS NOTED WITH (*) ARE AVAILABLE IN STX FINISH



78*
**SLIMLINE DOUBLE
MAGAZINE POUCH**

- Magazines are oriented "bullets out" to save space on belt
- Optimal for use on tactical rigs due to minimal width
- Vertical and horizontal belt slots
- Also available in tactical mounting configuration



79*
**SLIMLINE OPEN TOP
DOUBLE MAGAZINE POUCH**

- Magazines are oriented "bullets out" to save space on duty belt
- Optimal use on tactical rigs due to minimal width
- Vertical belt slots
- Also available in tactical mounting configuration



777*
**SLIMLINE TRIPLE
MAGAZINE POUCH**

- Magazines are oriented "bullets out" to save space on belt
- Optimal for use on tactical rigs due to minimal width
- Vertical and horizontal belt slots
- Also available in tactical mounting configuration



775*
**SLIMLINE OPEN TOP
TRIPLE MAGAZINE POUCH**

- Adjustable angle positions designed into belt loop
- Provides triple magazine retention without flap in an area comparable to standard dual magazine pouches
- Adjustable tension device to help retain magazines in pouch
- Also available in tactical mounting configuration

Duty Accessories

72

DOUBLE MAGAZINE AND CUFF POUCH

- Designed to fit two handgun magazines and one pair of handcuffs
- Adjustable tension device to help retain magazines in pouch



72



73

73

OPEN TOP DOUBLE MAGAZINE POUCH

- Features adjustable angle positions for both vertical and horizontal carry
- Tension screw allows retention adjustment

75*

OPEN TOP DOUBLE MAGAZINE POUCH

- Span between pouches, plus low cut allows for a quick and easy draw
- Tension screw allows retention adjustment



75*



76*



307* Light

76*

SINGLE MAGAZINE POUCH

- Several sizes to fit most popular magazines
- Also available in tactical mounting configuration

77*

DOUBLE MAGAZINE POUCH

- Several sizes to fit most popular magazines
- Also available in tactical mounting configuration



77*



307* EDW

307*

LIGHT/EDW CARTRIDGE HOLDERS

- Pouch fits most popular gun mounted lights
- Also designed for the Taser® cartridge
- Fits 2" to 2.25" (50mm-58mm) belt widths
- Also available in tactical mounting configuration

306*

OPEN TOP MINI-FLASHLIGHT HOLDER

- Half-sheath style fully protects selected mini flashlights

308*

HANDHELD FLASHLIGHT HOLDER

- Flap closure style to fit select hand-held lights
- Also available in tactical mounting configuration

35*

BATON HOLDER

- Extended baton can be reholstered
- Fits 16" (406cm), 21" (533cm) or 26" (660cm) expandable batons
- Also available in tactical mounting configuration



306*



308*



35*



135*

135*

BATON HOLDER

- Fits 16" (406cm), 21" (533cm) or 26" (660cm) expandable batons
- 26" length also fits Streamlight® Stinger® flashlight
- Available in two sizes for 1.5" and 2" - 2.25" (38mm-58mm) belts



62
BELT KEEPER

- Slot fits up to 1.75" (45mm) belts
- Hidden snap

63
SLOTTED BELT KEEPER

- Slotted, two-snap belt keeper
- Slot fits up to 1.75" (45mm) belt widths

65
BELT KEEPER

- Standard 0.75" (19mm) belt keeper
- Available in two sizes for 2" and 2.25" (50mm-58mm) belts

654
SLOTTED BELT KEEPER

- Slot fits up to 1.75" (45mm) belt widths
- 4-snap closure

655
HEAVY-DUTY BELT KEEPER

- Rugged, heavy-duty, two-snap belt keeper
- Extra wide at 1.25" (32mm)

HK-11
HIDE-A KEYPER™

- Hidden handcuff key in inside of belt keeper

67/67S
BATON RING

- Also fits C-cell flashlights
- 67 (not shown) is without snap

168
KEY RING (DOES NOT INCLUDE KEY)

- Heavy-duty metal spring hook
- Protective flap
- 2-snap design

169S
KEY RING

- Heavy-duty metal spring hook
- 1-snap design

170
SILENT KEY HOLDER

- SafariLaminate™ construction
- Hook and loop adjustable pouch



62



63



65



654



655



HK-11



67S



Does Not Include Key

168



169S



170

Duty Accessories

37-8*

OPEN TOP IMPACT ROUND HOLDER

- Open-top pouch for 37/40mm less lethal rounds
- Can be ordered for 2.25" (58mm) belt slide or mount on leg and vest accessory
- Also available in tactical mounting configuration

692S

BATON RING WITH SNAP

- For side-handle batons
- Snaps/slides on duty belt

730

HEAVY-DUTY FLASHLIGHT RING

- Features a shatter-resistant nylon ring
- 1-snap closure
- For D-cell and C-cell flashlights



38-8*

IMPACT ROUND CASE, TOP FLAP

- Closed top pouch for 37/40mm less lethal rounds
- Designed for the Defense Technology® eXact iImpact™ and Direct Impact® rounds
- Can be ordered for 2.25" (58mm) belt
- Also available in tactical mounting configuration

37*

OPEN TOP MACE®/OC SPRAY HOLDER

- Open-top for quick access
- Also available in tactical mounting configuration

38*

MACE®/OC HOLDER

- Top flap for added security
- Also available in tactical mounting configuration

090/090H

OPEN TOP HANDCUFF CASE

- Open-top thermoformed design
- Fits chain or hinged cuffs

33*

SURGICAL GLOVE HOLDER

- Hook and loop closure
- Holds one or three pair of surgical gloves; please specify

90/90H

HANDCUFF CASE

- Specify chain or hinged cuffs

190*/190H*

HANDCUFF CASE

- Specify chain (190) or hinged (190H)
- Also available in tactical mounting configuration

290/290H

DOUBLE HANDCUFF CASE

- Specify chain or hinged cuffs
- 290H (not shown) fits hinged cuffs

690

HANDCUFF STRAP

- Saves space on duty belt
- 1-snap design

764

RECORDER CASE

- Features a protective pouch and an adjustable bungee cord tie-down with a snap closure

768

COMPACT SPARE CUFF™ HOLDER

- Metal clip attachment to fit 2" to 2.25" (50mm-58mm) duty belt



37-8*



692S



730



37*



38*



33*



090



90



190*



290



690



764



768

Duty Accessories

BODY-WORN CAMERAS | CONCEALABLE ARMOR | TACTICAL ARMOR | COMMUNICATIONS | PATROL BIKE | DUTY GEAR/HOLSTERS | PROTECTIVE GEAR | FIREARMS ACCESSORIES | LETHAL | PERFORMANCE APPAREL | SURVIVABILITY SYSTEMS | FORENSICS | ARMOR SYSTEMS | TRAINING GROUP

761*
ADJUSTABLE RADIO HOLDER

- Adjustable bungee cord tie-down with a snap closure
- Fits most standard portable police radios

762*
RADIO HOLDER WITH SWIVEL

- Features a detachable swivel belt loop for easy retrieval
- Protective pouch and adjustable bungee cord tie-down with a snap closure

763
UNIVERSAL RADIO HOLDER - PORTABLE

- Universal fit
- Features an adjustable band to fit almost any standard portable police radio
- Bottom lip prevents the radio from falling through

766
RADIO HOLDER

- Adjustable bungee cord tie-down with snap closure
- Utilizes 745BL Belt Attachment – giving users the ability to clip on or off of the belt without removing other accessories
- Fits belt widths from 1.5" (38mm) to 2.25" (58mm)

080-12
SHOTGUN SHELL HOLDER

- Molded shotgun shell holder holds two 12-Gauge shells
- Belt clip features an extended bottom hook for security

CD-2
SPEEDLOADER HOLDER

- Strong, epoxy-coated steel clips
- Lined with a vinyl pad insert to ensure loader stability
- CD-2 clips firmly onto any belt up to 2" (50mm) wide
- Metal construction

371
SINGLE SPEEDLOADER HOLDER

- Ultra-low profile and quick, easy single-action draw – providing the fastest "top-flap" speedloader holder available
- Design carries cartridges on either side of the belt
- Allows user to grip both sides of the loader while unsnapping the top flap
- Fits 1.75" (45mm) belts

340
DOUBLE SPEEDLOADER HOLDER

- Standard double speedloader
- Chrome or brass snap



761*

762*

763

766

BACK



080-12



CD-2



371



340



Tactical & Military

TACTICAL & MILITARY

Safariland® tactical gear is a breed apart. Safariland products are battle-proven worldwide and offer an unmatched combination of quality, functionality and versatility in every product that carries our name. From leg-drop holsters and MOLLE-compatible attachment systems, to munitions carriers and more, Safariland gives you the tactical advantage you need to carry the day – day in and day out.

- All models available with dual or single strap thigh rigs
- All holsters available in STX Tactical® finishes (all colors) unless noted

TACTICAL HOLSTERS CAN BE CONFIGURED WITH ANY OF THESE ATTACHMENT SYSTEMS



Drop Flex Adapter



Universal Flex Adapter



Single Strap with D-Ring

SEE PAGE 73 FOR ALL MOUNTING OPTIONS



Single Strap LP with D-Ring



Single Strap



Single Strap with Quick Release



PATENTED

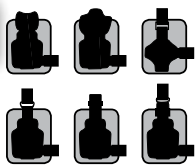

7004

7TS™ SLS TACTICAL HOLSTER

- SLS (Self Locking System) Rotating Hood
- Optional Sentry
- Constructed of SafariSeven™, a proprietary nylon blend that is completely non-abrasive to a firearm's finish
- Raised stand-off surfaces in holster's interior creates air space around the weapon allowing dirt and moisture to quickly clear any contact with the firearm
- Very high heat and low cold tolerances; structurally sound from 300°F to -50°F
- Available in SafariSeven Plain Black and FDE Brown finishes



PATENTED

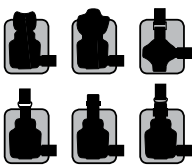

7304

7TS™ ALS® TACTICAL HOLSTER

- ALS® (Automatic Locking System) secures weapon once holstered; simple straight up draw once release is deactivated
- SLS (Self Locking System) Rotating Hood
- Optional Sentry
- Constructed of SafariSeven™, a proprietary nylon blend that is completely non-abrasive to a firearm's finish
- Raised stand-off surfaces in holster's interior creates air space around the weapon allowing dirt and moisture to quickly clear any contact with the firearm
- Very high heat and low cold tolerances; structurally sound from 300°F to -50°F
- Available in SafariSeven Plain Black and FDE Brown finishes

7005

7TS™ SLS TACTICAL HOLSTER WITH QUICK-RELEASE LEG STRAP



PATENTED

7305

7TS™ ALS® TACTICAL HOLSTER WITH QUICK-RELEASE LEG STRAP



PATENTED



7354

7TS™ ALS® TACTICAL HOLSTER



- ALS® (Automatic Locking System) secures weapon once holstered, simple straight up draw once release is deactivated
- Open-top design without SLS for quick retrieval of weapon
- Constructed of SafariSeven™, a proprietary nylon blend that is completely non-abrasive to a firearm's finish
- Raised stand-off surfaces in holster's interior creates air space around the weapon allowing dirt and moisture to quickly clear any contact with the firearm
- Very high heat and low cold tolerances; structurally sound from 300°F to -50°F
- Available in SafariSeven Plain Black and FDE Brown finishes
- Also optimized for MOLLE vest use (OMV version), Models 7384 and 7385



PATENTED

7TS



PATENTED

7355

7TS™ ALS® TACTICAL HOLSTER WITH QUICK-RELEASE LEG STRAP

6304RDS

ALS®/SLS TACTICAL HOLSTER

- ALS® (Automatic Locking System) secures weapon once holstered, simple straight up draw once release is deactivated
- SLS (Self Locking System) Rotating Hood
- For use with Red Dot Optic-equipped weapons
- Cordura® nylon wrap finish reduces infrared (IR) signature
- SafariLaminate™ thermoformed construction protects handgun and sights
- Suede lined to protect handgun's finish
- Available in Cordura® Nylon, MultiCam®, Ranger Green, Coyote, Khaki or STX finishes



PATENTED



PATENTED

6305RDS

ALS®/SLS TACTICAL HOLSTER WITH QUICK-RELEASE LEG STRAP

Tactical & Military



6004USN
LOW SIGNATURE SLS TACTICAL HOLSTER

- Features the SLS (Self Locking System) rotating hood system
- SLS allows for a smoother, single-motion draw
- Genuine SafariLaminate™ construction with suede lining to help protect the weapon's finish
- Cordura® nylon wrap finish reduces Infrared (IR) Signature
- Available in MultiCam®, Ranger Green, Coyote, Khaki and Black finishes



6004
SLS TACTICAL HOLSTER

- Features the SLS (Self Locking System) rotating hood system allowing for a smoother, single-motion draw and greater protection against attempted weapon takeaways
- Hood Guard is standard; optional Sentry available
- Suede lined to protect handgun's finish



6005
SLS TACTICAL HOLSTER WITH QUICK-RELEASE LEG STRAP

Shown here with optional Double Magazine Pouch mounted



6304
ALS®/SLS TACTICAL HOLSTER

- ALS® (Automatic Locking System) secures weapon once holstered
- SLS allows for a smoother, single motion draw and greater protection against attempted weapon takeaways
- Hood Guard is standard; optional Sentry available
- Simple straight up draw once all releases are deactivated
- Suede lined to protect handgun's finish



6305
ALS®/SLS TACTICAL HOLSTER WITH QUICK-RELEASE LEG STRAP



6354
ALS® TACTICAL HOLSTER

- ALS® (Automatic Locking System) secures weapon once holstered; simple straight up draw once release is deactivated
- Open-top design without SLS for quick retrieval of weapon
- Suede lined to protect handgun's finish
- Available in RDS model



6355
ALS® TACTICAL HOLSTER WITH QUICK-RELEASE LEG STRAP



6034

SLS AMBIDEXTROUS MILITARY TACTICAL HOLSTER

- Features the SLS (Self Locking System) rotating hood system allowing for a smoother, single-motion draw and greater protection against attempted weapon takeaways
- Ambidextrous body design
- Designed to accommodate the Beretta M9/92F or Sig P226 pistol with or without a light or LAM unit
- Hood Guard is standard; optional Sentry available
- Also available with Mid-ride UBL (6230) or Low-ride UBL (6235)



6035

SLS MILITARY TACTICAL HOLSTER WITH QUICK-RELEASE LEG STRAP



6384

ALS® OMV TACTICAL HOLSTER

- ALS® (Automatic Locking System) secures weapon once holstered; simple straight up draw once release is deactivated
- Holster is optimized for MOLLE vest use (OMV), with lower center of gravity than most other Safariland® duty and tactical holsters for less pulling on vest
- Open-top design without SLS for quick retrieval of weapon
- Hood Guard is standard; optional ALS Guard available
- Suede lined to protect handgun's finish
- Available in RDS Model

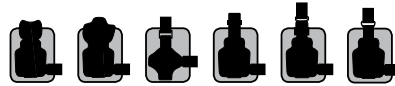

Tactical & Military



6385
ALS® OMV TACTICAL HOLSTER WITH QUICK-RELEASE LEG STRAP

- Adjustable vertical leg strap with quick-release detachable leg harness



6384 Holster with MLS 16 on Vest



6378USN
ALS® LOW SIGNATURE HOLSTER

- ALS (Automatic Locking System) secures weapon once holstered, simple straight up draw once release is deactivated
- Reduces Infrared (IR) Signature
- Compact profile for minimal interference with other equipment
- Optional ALS Guard (Model 6006) available for increased security
- Available in MultiCam®, Ranger Green, Coyote or Khaki finishes
- Available for Beretta M9/M9A1/92F, Glock 19/23 and Sig Sauer P226



ALS MILITARY KIT

- ALS (Automatic Locking System) secures weapon once holstered, simple straight up draw once release is deactivated
- Open-top design without SLS for quick retrieval of weapon
- Single strap leg shroud with Quick Locking Receiver Plate (QLS 22) and a 568BL Paddle
- 567BL Injection-Molded Belt Loop with a Quick Locking Receiver Plate (QLS 22). The 567BL can be modified to fit 1.5", 1.75", 2" and 2.25" belt slot with a 1" drop
- Adjustable shoulder harness with Quick Locking Receiver Plate (QLS 22)
- MOLLE Locking Fork (MLS16) with Quick Locking Receiver Plate (QLS 22) mount included for MOLLE chest carry



Leg Shrouds & Accessories

All leg shrouds and accessories are available in Black, Foliage Green, OD Green, FDE Brown or Coyote Brown finishes.

ADDITIONAL PRODUCTS ON PAGES 86 AND 87

ALL TACTICAL ACCESSORIES ON THIS PAGE CAN BE ORDERED WITH THE MLS 16 OR ELS 34 LOCKING FORK ALREADY ATTACHED

6005-6 STANDARD DOUBLE LEG SHROUD WITH QUICK-RELEASE STRAP

- Features harness and shroud to mount holsters and accessories
- Leg shroud features silicon strap for non-slip traction
- Ambidextrous

36 OC HOLDER

- Made specifically to hold the MK-9 series of aerosols
- Open-top design for quick retrieval yet sturdy product retention

34 OC HOLDER

- Made specifically to hold the Defense Technology® Instantaneous Blast
- Open-top design for quick retrieval yet sturdy product retention

085 SHOTGUN SHELL HOLDER



6004-10 SINGLE STRAP LEG SHROUD

- Lower profile leg shroud
- Can mount accessories on both sides of holster or be used for three accessories
- Adjustable vertical leg strap to adjust ride height

774 RIFLE MAGAZINE POUCH



40 DISTRACTION DEVICE® HOLDER

- Fits several Defense Technology® Distraction Device® models

37-8 OPEN TOP IMPACT ROUND HOLDER

- Belt slide or mount on leg and vest accessory

4331 MOLLE BATTLE BELT

- For ultimate comfort; distributing the carried weight evenly on the hip, while the padded mesh lining and contoured shape provide all-day comfort
- Two rows of MOLLE loop webbing run the length of the belt, providing ample space for multiple accessory attachments
- Provides a stable platform to attach a holster with a UBL (Universal Belt Loop) or Tactical Leg Shroud system
- Anti-bacterial and anti-microbial foam padding on the inside liner
- High-quality, durable and shatter-resistant buckle; use with 029 Liner Belt with the 029 Liner Belt
- Available in Black and Tan

6004-10 shown here with accessories attached

6004-6 STANDARD DOUBLE LEG SHROUD

- Features harness and shroud to mount holsters and accessories
- Ambidextrous

37-8 OPEN TOP IMPACT ROUND HOLDER

76 SINGLE MAGAZINE POUCH

78 SLIMLINE DOUBLE MAGAZINE POUCH



4333/4333WP LOW PROFILE BATTLE BELT

- Provides non-slip stability necessary for reducing back strain and general discomfort frequently caused by loose-fitting, drooping and weighted-down belts
- Two rows of MOLLE webbing; weight is distributed evenly on the hip Available with or without a back pad
- AustriAlpin Cobra Buckle – rated for forces up to 9 kN (straight) or 18kN (looped)
- Available in Black and Tan
- Available with or without support back pad

6004-6 shown here with accessories attached



Leg Shrouds & Accessories

CONCEALABLE ARMOR | TACTICAL ARMOR | COMMUNICATIONS | DUTY GEAR/HOLSTERS | PROTECTIVE GEAR | ACCESSORIES | FIREARMS | LESS LETHAL | PERFORMANCE APPAREL | SURVIVABILITY SYSTEMS | FORENSICS | ARMOR SYSTEMS | TRAINING ACADEMY



6004-27 DROP FLEX ADAPTER ON SINGLE LEG SHROUD W/ QLS 22

- Allows user to wear a thigh rig higher on the leg with more stability, eliminating leg shroud movement
- Sits low enough for use with body armor and in vehicles, while also providing two mounting points for accessories
- Includes QLS 22 Receiver Plate (can also be ordered with MLS Receiver Plate or plain)
- Fits belt widths up to 2.25" (58mm)
- Available in Black, Foliage Green, FDE Brown or Coyote Brown finishes



Shown here with 568BL Paddle and 6004-10 Single Strap Leg Shroud



6004UFA UNIVERSAL FLEX ADAPTER

- Allows user to wear a thigh rig below the hip without shifting weight farther down the leg
- Hole pattern on UFA makes connecting to various mounts possible including 568BL Paddle, ELS Fork, QLS Fork or 745BL Belt Clip
- For use in conjunction with 6004-10 Leg Shroud

6009-110 SINGLE STRAP LEG SHROUD WITH D-RING

- Utilizes a unique D-Ring on the strap for increased leg flexibility
- Single leg strap design
- Minimally-sized leg shroud for decreased footprint on the thigh



6005-10 SINGLE STRAP LEG SHROUD WITH QUICK-RELEASE

- Features harness and shroud only to mount accessories and holsters
- Leg straps feature silicone strips for non-slip traction
- Ambidextrous



6009VE D-RING STRAP WITH ENHANCED HOOK & LOOP BELT ATTACHMENT

6005VE QUICK-RELEASE BUCKLE WITH ENHANCED HOOK & LOOP BELT ATTACHMENT

- Fits Safariland® tactical leg shrouds
- Belt attachment portion can be detached when not needed
- Secondary hook and loop flap ensures continuous attachment to belt when in use
- 6009VE model provides easy lateral movement



6009VE



6005VE

6009-11 D-RING STRAP

- Provides easy lateral movement
- Fits all Safariland® tactical shrouds



6004-11 VERTICAL LEG STRAP

- Fits tactical holster systems
- Replacement strap for standard tactical rigs



Leg Shrouds & Accessories



6005-23
MLS ACCESSORY FORKS ON QUICK-RELEASE STRAP

- Allows mounting of any tactical holster, with quick-release leg strap, directly to the MOLLE loops on the side of a vest or MOLLE web belt
- Enables user to forgo wearing a belt and put the weight onto a load-bearing vest and thigh rig
- Ideal for combining with a tactical vest, without having to make any changes to a duty belt, to be ready as a first responder
- Also available with QLS fork



6009-23
MLS ACCESSORY FORK ON D-RING

- Allows mounting of any tactical holster with D-Ring strap directly to the MOLLE loops on the side of a vest or MOLLE web belt
- Enables user to forgo wearing a belt and put the weight onto a load-bearing vest and thigh rig



BACK

MSA
MOLLE SLIDING ADAPTER

- Compatible with Model 71 Tactical Universal Magazine Pouch
- Easily slides and locks into MOLLE webbing; removable in seconds
- Minimal space used on MOLLE vests
- Permits multiple pouches lined up side to side



774
RIFLE MAGAZINE POUCH

- Clip-on belt attachment to fit 1.5" (38mm) to 2.25" (58mm) belts
- Adjustable for carry angle
- SafariLaminate™ thermoformed construction with tension device
- Ambidextrous
- Can be ordered with ELS Locking Forks attached
- Available in Black, Foliage Green, FDE Brown or Coyote Brown finishes



TMA
TACTICAL MOLLE ADAPTER

- For use with Safariland® 3-hole patterned holsters
- Easily adjusts with Phillips screwdriver
- Full 360° cant
- Comes standard with MLS 16 MOLLE Locking Fork or as stand alone model
- Available in Black



4555
SHOOTERS' RANGE BAG

- Removable center carry compartment has zippered, padded side panels for four separate handgun compartments
- Adjustable hook and loop dividers to personalize accessory space
- Magazine pouches conveniently sewn into main storage area
- Two large exterior pockets, two large end pockets with flap closure, and a fully lined interior
- Full-wrap carry handles make it easy to move gear to different shooting stations
- Outer carry bag has dual zipper top for easy access and full coverage, flat side zipper pocket, ID window, and large outside zippered pocket for towel, shooting glasses or hearing protection
- Overall dimensions: 14" x 9" x 10"

GUN CASES

Safariland® gun cases are feature-laden, made from rugged ballistic pack cloth and are offered in Black only unless otherwise specified

4553

PREMIUM DUAL HANDGUN CASE

- Full interior closed-cell foam surrounded by soft lining for safe handgun storage
- Four outside magazine/accessory pouches
- Dual concealed pockets to individually protect handgun
- 12" length to carry up to 6" handguns
- Wraparound handles



4552

DUAL RIFLE CASE

- Heavy-duty lockable zippers, one adjustable outside covered accessory pouch
- Large dual handgun/accessory pouch with individual hook and loop enclosed handgun areas
- Closed-cell protective foam padding and 2" perimeter lip
- Assorted accessory pockets inside case
- Adjustable padded shoulder harness for shoulder carry
- Includes adjustable backpack-style carry straps that tuck away in storage pocket when not in use
- Available in Black or Tan and in 36" or 46" lengths



NEW

4566

ENHANCED 3-GUN BAG

- Heavy-duty lockable zippers, two adjustable outside accessory pouches
- Large dual handgun/accessory pouch with individual hook and loop enclosed handgun storage areas, and four pistol mag pouches large enough for extended magazines
- Closed-cell protective foam padding and 2" perimeter lip
- Assorted accessory pockets inside case
- Adjustable padded shoulder harness for shoulder carry
- Includes adjustable backpack-style carry straps that tuck away in storage pocket when not in use
- Unique zippered barrel expansion slot on side of case can be opened to allow use of longer firearms (up to 55")
- 51" overall length (with expansion slot closed)



Quick Attachment Systems

Safariland® Quick Attachment Systems, consisting of the QLS, ELS and MLS, represent the coming together of technology, with the requirement for modular and versatile products. Originally designed for the military to quickly transfer the holster from the leg to the vest, the QAS family has now gone beyond strictly military functions to include law enforcement, concealed carry and sporting applications. Whether the scenario facing you involves the need to adjust holster location to conserve space while boarding an APC, or to quickly switch out magazine types before the latest 3-Gun match, the QAS family of products will help accomplish your goals.

MLS (MOLLE LOCKING SYSTEM)

- Provides a holster or accessory with a quick, easy, and secure attachment to any MOLLE loop-equipped apparel
- Allows for quick removal and installation between attachment points such as the MOLLE vest, belt loop, and/or tactical leg shroud
- Allows many types of Safariland holsters and accessories to be mounted at various orientations and angles to suit the needs and preferences of the individual user
- Operator can rearrange gear quickly and easily without the use of tools
- Allows holstered weapons and accessories to be removed without removing apparel, such as vest, leg shroud or belt
- Mount almost any holster or accessory in the right position for any mission

PATENTED

MLS16

1. MLS 16 ACCESSORY LOCKING FORK

- Threads directly through MOLLE loops to mount pouches, or into the back of the QLS 22 or ELS 35 for attachment of pouches and holsters to vests
- Colors: Black, Foliage Green, OD Green, FDE Brown or Coyote Brown finishes



ELS (EQUIPMENT LOCKING SYSTEM)

- Provides a mounting platform for any tactical and competition accessories to be placed in various locations, including belt clips and tactical rigs or directly on MOLLE loops with the use of an MLS 16 Locking Fork
- Fork attaches to any tactical or competition accessory, including the 774 Rifle Magazine Pouch, 78 Slimline Dual Magazine Pouch, and Impact Round cases
- Receiver plate mounts to any thigh rig, 744BL belt clip or MLS 16 fork (for use of ELS on MOLLE loops), or can be attached directly to the pre-cut mounting holes on any QAS belt
- A quick pinch of the thumb and index finger allows the removal of any product attached to the fork unit for attachment on any other ELS 35 location
- May be purchased with or placed directly onto the 744BL belt clip for convenient waistline location
- Useful in quickly switching out accessories while maintaining the same root product, whether it be a belt, thigh rig or magazine pouches for a competition event, etc.
- Very small receiver footprint (1 7/8" W x 2 3/4" H)

PATENTED

ELS 34 & 35

1. ELS 34 EQUIPMENT LOCKING FORK

- Mounts to any tactical accessory, then connects to the ELS 35 Receiver Plate
- Colors: Black, Foliage Green, OD Green, FDE Brown, or Coyote Brown finishes

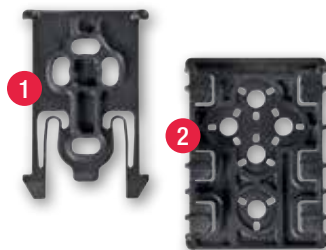

2. ELS 35 EQUIPMENT RECEIVER PLATE

- Mount platform for tactical thigh rig or any other two-hole accessory location
- Colors: Black, Foliage Green, OD Green, FDE Brown, or Coyote Brown finishes





QLS (QUICK LOCKING SYSTEM)

- The QLS provides officers the ability to easily and quickly remove and secure their weapon without having to remove weapon from holster. Especially effective in correctional institutions and courthouse appearances
- Effective for concealed carry in ease of transferring gun from body to other mounting point, such as vehicle
- Mount almost any Safariland® duty holster on an equipment belt with use of the Safariland UBL
- Provides a highly versatile holster system with a quick, easy and secure attachment to a variety of locations – belt, thigh rig, furniture, or vehicle, etc. Can also be used with the Safariland MLS 16 Accessory Locking Fork for attachment to MOLLE vests
- QLS System passes Level I Retention™ pull test

PATENTED



QLS 19 & 22

FOR DUTY USE – PASSES LEVEL I RETENTION™ TEST

1. QLS 19 DUTY HOLSTER LOCKING FORK

- Mounts directly to the back of any 3-hole pattern holster, then connects to the QLS 22 Receiver Plate
- Colors: Black, Foliage Green, OD Green, FDE Brown or Coyote Brown finishes

2. QLS 22 DUTY RECEIVER PLATE

- Mounting platform for the QLS 19 Duty Locking Fork. Attaches directly to Universal Belt Loop (UBL), thigh rig or other mounting platforms
- Colors: Black, Foliage Green, OD Green, FDE Brown or Coyote Brown finishes

3. QLS 22L DUTY RECEIVER PLATE

- Same as the QLS 22 with an extra locking feature

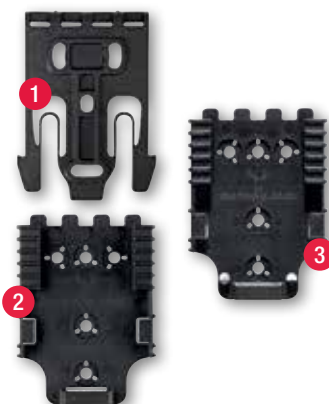

QAS BELTS

FOR MORE INFORMATION PLEASE SEE CORRESPONDING PAGE



032
ELS COMPETITION BELT 1.75"
(45MM)

SEE MORE ON PAGE 102

QLS/MLS Tactical

QLS TACTICAL



QLS ON A DUTY BELT

1. QLS 22 W/ UBL ON BELT
2. QLS 19 ON HOLSTER BACK
3. QLS 22 W/ UBL W/ QLS 19 ON HOLSTER



QLS ON A MOLLE VEST

1. MLS 16 ON VEST
2. QLS 22 W/ MLS 16 ON VEST
3. QLS 22 ON MLS 16 W/ QLS 19 ON HOLSTER



QLS ON A THIGH RIG

1. ATTACH QLS 22 TO THIGH RIG
2. ATTACH QLS 19 TO BACK OF HOLSTER
3. QLS 22 ON SHROUD W/ QLS 19 HOLSTER

CONCEALMENT/PERSONAL PROTECTION



QLS IN VEHICLE

1. QLS 22 ON PADDLE W/ QLS 19 ON HOLSTER
2. REMOVING HOLSTER FROM QLS 22
3. TRANSFERRING HOLSTER TO QLS 22 MOUNTED IN VEHICLE



QLS AT HOME

1. QLS 22 ATTACHED TO DRESSER
2. QLS 22 ON DRESSER W/ QLS 19 ON HOLSTER



QLS AT HOME

1. QLS 22 ON SAFE WALL
2. QLS 22 ON SAFE WALL W/ QLS 19 ON HOLSTER

MLS TACTICAL



MLS ON A VEST

1. HOLSTER W/ MLS 15 THREADED DIRECTLY THROUGH MOLLE LOOPS



6004-24

MLS ACCESSORY FORK ON SMALL MOLLE PLATE

- A mount with the MLS 16 Accessory Fork already affixed; attaches to existing MOLLE pouches, then is easily threaded directly through MOLLE loops

ELS Tactical/Competition

ELS TACTICAL



ELS ON A LEG SHROUD

1. (2) ELS 35s ON LEG SHROUD
2. ELS 34 W/ RIFLE MAGAZINE POUCH & ELS 34 W/ PISTOL MAGAZINE POUCH
3. (2) ELS 35s ON LEG SHROUD W/ (2) ELS 34s ON RIFLE & PISTOL MAGAZINE POUCH

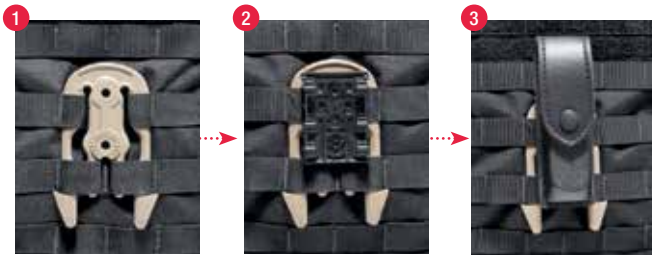

ELS ON MOLLE VEST

1. MLS 16 ON VEST
2. ELS 35 W/ MLS 16 ON VEST
3. ELS 34 W/ MAGAZINE POUCH W/ ELS 35 ON MLS 16 ON VEST

ELS ON A TACTICAL BELT

1. 4332 ELS TACTICAL BELT
2. ELS 34 W/ RIFLE MAGAZINE POUCH
3. ELS 34 W/ 40MM GRENADE HOLDER
4. 4332 BELT W/ (3) ELS 35 RECEIVER PLATES AND READY TO MOUNT ACCESSORIES WITH ELS FORKS



ELS COMPETITION



ELS ON A COMPETITION BELT

1. 032 BELT W/ ELS 34 & ELS 35
2. ELS 34 ON MAGAZINE POUCH
3. 032 ELS COMPETITION BELT FULLY RIGGED W/ HOLSTER, (4) ELS 35s & (2) 773 MAGAZINE POUCHES W/ ELS 34s



6005-23

MLS ACCESSORY FORK ON QUICK RELEASE HARNESS

- Allows mounting of any tactical holster with quick-release leg strap directly into the MOLLE loops on the side of a vest or MOLLE web belt
- Enables user to forgo wearing a belt and put the weight onto a load-bearing vest and thigh rig

6009-23

MLS ACCESSORY FORK ON D-RING

- Allows mounting of any tactical holster with D-Ring strap directly to the MOLLE loops on the side of a vest or MOLLE web belt
- Enables user to forgo wearing a belt and put the weight onto a load-bearing vest and thigh rig



QAS KITS

Kit	Contents
QUICK-KIT 1	(1) QLS 19, (1) QLS 22
QUICK-KIT 2	(1) QLS 19, (1) QLS 22L
QUICK-KIT 3	(1) QLS 19, (2) QLS 22
QUICK-KIT 4	(1) QLS 19, (2) QLS 22L
ELS-KIT 1	(2) ELS 34, (2) ELS 35

*ALL KITS INCLUDE MOUNTING HARDWARE

Concealment Holsters



PATENTED

6367

ALS®/SLS BELT LOOP

- ALS® (Automatic Locking System) secures weapon once holstered; simple straight up draw once all releases are deactivated
- Includes SLS hood assembly and Hood Guard
- Optional Sentry available
- Available in Plain Black or STX Tactical® finishes



PATENTED



6378

ALS® CONCEALMENT PADDLE & BELT LOOP COMBO

- ALS® (Automatic Locking System) secures weapon once holstered; simple straight up draw once ALS is deactivated by thumb while obtaining shooting grip
- Injection-molded paddle design is highly concealable and rides close to body
- Injection-molded belt loop is user adjustable for cant and can be worn crossdraw
- IDPA approved
- Optional ALS® Guard available for increased security
- Genuine SafariLaminate™ thermoformed construction with suede lining to help protect the gun's finish
- Available in STX finishes

6376

HI-RIDE BELT SLIDE

- Rides 1" higher than standard belt slide
- Available in 1.5" (38mm) and 1.75" (45mm) belt width



PATENTED

6379

BELT CLIP

- Features 745BL Belt Clip for easy attachment and detachment from belt
- Fits belt widths from 1.5" (38mm) to 2.25" (58mm)



PATENTED



The ALS® or Automatic Locking System provides a high level of security without adding thumb breaks, snaps, or levers requiring the use of the trigger finger. With several patents to its credit, the key to this system is an internal locking device that secures the weapon in all directions simply upon re-holstering. Holsters with this advanced ergonomic design are completely operable with the thumb, making training easy, and the straight-up draw makes it very instinctive to use, yet difficult for anyone other than the wearer to access.

1. Upon drawing, press back on the ALS lever for a smooth and easy straight up draw.
2. Automatically locks weapon in place upon holstering.



Concealment Holsters



PATENTED

7377

7TS™ ALS® CONCEALMENT BELT LOOP

- ALS® (Automatic Locking System) secures weapon once holstered, simple straight up draw once release is deactivated
- Open-top design without SLS for quick retrieval of weapon
- Constructed of SafariSeven™, a proprietary nylon blend that is completely non-abrasive to a firearm's finish
- Raised stand-off surfaces in holster's interior creates air space around the weapon allowing dirt and moisture to quickly clear any contact with the firearm
- Very high heat and low cold tolerances; structurally sound from 300°F to -50°F
- Injection-molded belt loop is user adjustable for cant and can be worn crossdraw
- Available in SafariSeven Plain Black and FDE Brown finishes



PATENTED

7378

7TS™ ALS® CONCEALMENT PADDLE AND BELT LOOP COMBO

- ALS® (Automatic Locking System) secures weapon once holstered; simple straight up draw once release is deactivated
- Open-top design without SLS for quick retrieval of weapon
- Constructed of SafariSeven™, a proprietary nylon blend that is completely non-abrasive to a firearm's finish
- Raised stand-off surfaces in holster's interior creates air space around the weapon allowing dirt and moisture to quickly clear any contact with the firearm
- Very high heat and low cold tolerances; structurally sound from 300°F to -50°F
- Includes injection-molded belt loop; is user adjustable for cant and can be worn crossdraw
- Available in SafariSeven Plain Black and FDE Brown finishes



PATENTED

7371

MICRO PADDLE

- For single stacked sub-compact pistols
- 571BL injection-molded micro paddle design is highly concealable and rides close to the body
- Fits belt widths from 1.5" (38mm) to 1.75" (45mm)



PATENTED

7376

HI-RIDE BELT SLIDE

- Rides 1" higher than standard belt slide
- Available in 1.5" (38mm) and 1.75" (45mm) belt widths



PATENTED

7379

BELT CLIP

- Features 745BL Belt Clip for easy attachment and detachment from belt
- Fits belt widths from 1.5" (38mm) to 2.25" (58mm), release is deactivated



7TS



PATENTED

7367

7TS™ ALS® / SLS CONCEALMENT BELT SLIDE

- ALS® (Automatic Locking System) secures weapon once holstered, simple straight up draw once release is deactivated
- SLS (Self Locking System) Rotating Hood; optional Sentry
- Injection-molded belt loop is user adjustable for cant and can be worn crossdraw
- Constructed of SafariSeven™, a proprietary nylon blend that is completely non-abrasive to a firearm's finish
- Raised stand-off surfaces in holster's interior creates air space around the weapon allowing dirt and moisture to quickly clear any contact with the firearm
- Very high heat and low cold tolerances structurally sound from 300°F to -50°F
- Available in SafariSeven™ Plain Black and FDE Brown finishes



PATENTED

537

GLS™ OPEN TOP CONCEALMENT BELT SLIDE

- GLS™ (Grip Locking System) secures weapon once holstered; retention is deactivated with the middle finger upon a standard shooting grip on the weapon
- Soft, flexible holster body allows holster to mold around wearer
- Tension adjustment to customize tailor weapon fit to user preferences
- Fits 1.5" (38mm) belt widths
- Available in Plain Black



6287

SLS CONCEALMENT BELT LOOP

- Concealment version of the SLS holster
- Features a unique rotating hood design and semi-hi-ride position with slightly forward cant
- Rides close to the body, aiding in concealment and weapon retention
- Adjustable tension device
- Available in Plain Black or STX Tactical® finishes



PATENTED

6367

ALS®/SLS BELT LOOP

- ALS® (Automatic Locking System) secures weapon once holstered; simple straight up draw once all releases are deactivated
- Includes SLS hood assembly and Hood Guard
- Optional Sentry available
- Available in Plain Black or STX Tactical® finishes

Concealment Holsters

578

GLS™ PRO-FIT™ CONCEALMENT PADDLE & BELT LOOP COMBO

- GLS™ (Grip Locking System) secures weapon once holstered; retention is deactivated with the middle finger upon a standard shooting grip on the weapon
- Designed to fit over 250 pistols in one holster, adjustment available to further customize fit
- Body is proprietary nylon blend that is non-abrasive to a firearm's finish, maintains very high heat and low cold tolerances
- Low-cut and compact design make concealment easy while also allowing for a quick draw
- Injection-molded paddle design is highly concealable and rides close to body
- Injection-molded belt loop is user adjustable for cant and can be worn cross draw
- Available in SafariSeven™ Plain Black and FDE Brown finishes

HOLSTER BODY SIZE NOW AVAILABLE FOR NARROW FRAME GLOCK, SMITH & WESSON SHIELD, SPRINGFIELD XDS

7TS



PATENTED



PATENTED

576

HI-RIDE BELT SLIDE

- Rides 1" higher than standard belt slide
- Available in 1.5" (38mm) belt width



PATENTED

579

BELT CLIP

- Features 745BL Belt Clip for easy attachment and detachment from belt
- Fits belt widths from 1.5" (38mm) to 2.25" (58mm)



PATENTED

577

BELT LOOP

- Injection-molded belt loop is user adjustable for cant and can be worn cross draw
- Available for 1.5" (38mm), 1.75" (45mm), 2" (50mm), or 2.25" (58mm) belt slots; please specify



PATENTED

571

PRO-FIT CONCEALMENT WITH MICRO PADDLE

- For single stacked sub-compact pistols
- Features the 571BL injection-molded design, rides close to body
- Fits belt widths from 1.5" (38mm) to 1.75" (45mm)



The GLS™ (Grip Locking System) is a unique retention device in which the middle finger is used to release the firearm.

1. During the draw, depress the lever for a smooth and easy straight up draw.
2. Automatically locks weapon in place upon holstering.



Concealment Holsters



5198

OPEN TOP CONCEALMENT PADDLE & BELT LOOP COMBO

- Detent in trigger guard for reliable weapon security
- Low-cut sides for ease of draw and added comfort
- Belt loop is user adjustable for cant angle; can even be worn cross draw
- Injection-molded paddle design is highly concealable and rides close to the body
- IDPA approved
- Genuine SafariLaminate™ thermoformed construction
- Available in Black and Red, STX Finishes
- Model 5188 available for light mounted weapons



5198 AVAILABLE IN RED



547

PRD™ OPEN TOP CONCEALMENT BELT SLIDE

- Pinch Retention Device (PRD™) secures weapon once it is fully seated in the holster by clamping onto both sides of the trigger guard; draw is initiated by pulling up through device
- Low-profile design with wide weight disbursement for a comfortable carry and high concealability
- Fits 1.5" (38mm) or 1.75" (45mm) belt widths
- Available in all STX Finishes



557

OPEN TOP CONCEALMENT BELT SLIDE

- Ejection port detent secures gun once fully seated in the holster by clamping onto the ejection port; draw is initiated by pulling through detent
- Low-profile design with wide weight disbursement for a comfortable carry and excellent concealability
- Works with or without light on handgun
- Fits belt widths from 1.5" (38mm) to 1.75" (45mm)
- Available in STX finishes



5197

RANGE SERIES OPEN-TOP MID-RIDE

- Adjustable belt loop eliminates common belt-bulging and does not interfere with draw
- Compact and lightweight with low-cut sides for ease of draw
- Detent in trigger guard for reliable handgun security
- Belt loop is user adjustable for cant angle; can also be worn cross draw
- IDPA approved
- Available in 1.5" (38mm) and 1.75" (45mm) belt widths
- Available in Black or Red, in STX finish



PATENT PENDING

5199

BELT CLIP

- Features 745BL Belt Clip for easy attachment and detachment from belt
- Fits belt widths from 1.5" (38mm) to 2.25" (58mm)



5196

HI-RIDE BELT SLIDE

- Rides 1" higher than standard belt slide
- Available in 1.5" (38mm) belt width



PATENTED

568

CUSTOM FIT PADDLE & BELT LOOP COMBO

- 6 pistol and 4 revolver fits accommodate over 200 different weapons
- Injection-molded paddle designed for concealability and comfort
- IDPA approved
- Genuine SafariLaminate™ thermoformed construction with suede lining to help protect the gun's finish
- Available in STX Plain Black finish



PATENTED

567

CUSTOM FIT BELT LOOP

- 6 pistol and 4 revolver fits accommodate over 200 different weapons and are IDPA approved
- Belt loop is user-adjustable for cant angle; can also be worn cross draw
- Genuine SafariLaminate™ thermoformed construction with suede lining to help protect the gun's finish
- Available in STX Plain Black finish



PATENTED

566

HI-RIDE BELT SLIDE

- Rides 1" higher than standard belt slide
- Available in 1.5" (38mm) belt widths



PATENTED

569

BELT CLIP

- Features 745BL Belt Clip for easy attachment and detachment from belt
- Fits belt widths from 1.5" (38mm) to 2.25" (58mm)



18

IWB HOLSTER

- Open-top design
- Firm SafariLaminate™ construction allows holster to stay open for ease of reholstering
- SafariSuede™ outer material grips clothing for less movement of holster
- Fits both 1.25" (32mm) and 1.5" (38mm) belt widths
- Double-snap belt loop is adjustable for holster cant
- Available in Black sueded finish



25

INSIDE-THE-POCKET HOLSTER

- Extra-thin, extra-soft holster for extra-deep concealment
- Holster will stay open; simply drop handgun into the pocket and it holsters itself
- Suede outer material grips clothing for less movement of holster
- Firm, moisture-proof membrane layer prevents perspiration from penetrating the holster and collecting on the gun
- Available in Black sueded finish



Low-Profile Draw



Shown in Pocket

Concealment Holsters



PATENTED

575

GLS™ PRO-FIT INSIDE WAISTBAND HOLSTER

- GLS™ (Grip Locking System) secures firearm once holstered; retention is deactivated with the middle finger upon obtaining a standard shooting grip on the firearm
- Designed to fit multiple firearms in one holster
- Body is proprietary nylon blend that is non-abrasive to firearm's finish
- Low-cut compact design make concealment easy while allowing for a quick draw
- Inside-the-waist for deep concealment
- Fully adjustable cant
- Available in SafariSeven™ Plain Black



NEW SIZE

NEW for 2019
Now available fits for single stack, sub-compacts:

- Springfield XDS, Glock 43, S&W Shield 9mm/40, and .45



27

INSIDE-THE-PANTS CONCEALMENT HOLSTER

- J-shaped belt hook can be worn with any belt
- Designed for undercover duty use with open-top design for quick access
- SafariLaminate™ thermoformed construction
- A polymer insert keeps the holster open for easy weapon reholstering
- Available in Plain Black finish



177

IWB HOLSTER WITH J-HOOK

- Open-top tuckable design
- Firm SafariLaminate™ construction allows holster to stay open for ease of reholstering
- J-Hook attachment provides strong belt retention on holster while minimizing its visibility
- Fits 1.75" (45mm) belt width
- Available in Black



17

IWB HOLSTER

- Open-top design
- Firm SafariLaminate™ construction allows holster to stay open for ease of reholstering
- Heavy-duty spring-steel belt clip securely anchors holster to belt or trousers
- Fits up to 1.75" (45mm) belt width
- Available in Black

Shoulder Holsters



PATENTED

7053 7TS™ ALS® LIGHTWEIGHT SHOULDER HOLSTER

- ALS (Automatic Locking System) secures weapon once holstered; simple straight out draw once ALS is deactivated by thumb while obtaining shooting grip
- Proprietary SafariSeven™ material nearly impervious to heat, cold and water
- One handed reholstering
- Lightweight, adjustable elastic single side harness provides stability for handgun
- Belt tie-downs not needed due to lightweight and compact design
- Harness compatible with all 7TS holsters
- Available in SafariSeven Plain Black and FDE finishes



PATENTED

1051 ALS® SHOULDER HOLSTER

- ALS® (Automatic Locking System) secures weapon once holstered
- SafariLaminate™ thermoformed construction for ease of draw and reholstering with one hand
- Vertical or horizontal carry options
- Harness system is comfortable and fully adjustable
- For pistols only
- Dual magazine pouch included on strong side
- Available in Plain or STX Plain Black finishes

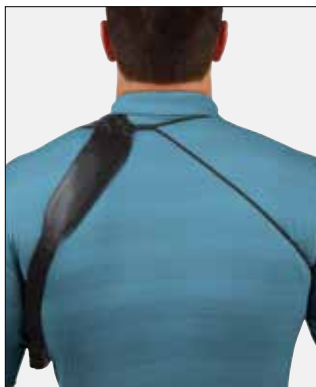

Back View



Can Be Worn Vertical or Horizontal



Back View

Concealment Accessories

CONCEALABLE ARMOR | TACTICAL ARMOR | COMMUNICATIONS | DUTY GEAR/HOLSTERS | PROTECTIVE GEAR | ACCESSORIES | FIREARMS | LESS LETHAL | PERFORMANCE APPAREL | SURVIVABILITY SYSTEMS | FORENSICS | ARMOR SYSTEMS | TRAINING ACADEMY



71
INJECTION MOLDED SINGLE MAGZINE POUCH

- Flexible “accordion” design allows for multiple fits and minimal size
- Fits magazines (single or double stack), flashlights, knives and multi-tools
- Available in Black or Tan
- Fits 1.5” (38mm) to 2.25” (58mm) belt widths
- Can now be ordered as a tactical accessory to be used with Safariland® leg shrouds or the QAS System; also available as an IWB, with a belt clip, or for use with the MSA



574
MAGAZINE HOLDER AND LIGHT POUCH - PADDLE

- Adjustable tension device
- Paddle design features a self-locking hook
- Fits belt widths up to 1.75” (45mm)

81
OPEN TOP SINGLE MAGZINE-SNAP

- Back side folds over to form snap-type belt loop
- For use on belts up to 1.75” (45mm)
- Available in Plain Black finish

CD-AUTO
AUTO MAGAZINE HOLDER

- Black metal clip-on design

079
OPEN TOP DOUBLE MAGAZINE POUCH - SNAP

- For use on belts up to 1.75” (45mm) wide
- Adjustable tension device
- Available in Plain Black, Basketweave, or STX finishes

123
MAGAZINE POUCH - HORIZONTAL

- Carries magazines in a horizontal position
- Hook and loop belt attachment wraps around belt
- Available in Plain Black finish

572
OPEN TOP DOUBLE MAGAZINE POUCH - PADDLE

- Adjustable tension device
- Available in Plain Black, Basketweave, or STX finishes



81



CD-AUTO



079



123

573
MAGAZINE HOLDER & HANDCUFF POUCH

- Paddle design features a self-locking belt hook
- Adjustable tension device
- Available in Plain Black finish

590
MAGAZINE HOLDER & HANDCUFF POUCH

- Paddle design features a self-locking belt hook
- Adjustable tension device
- Available in Plain Black finish

7350
BADGE HOLDER

- Three sizes for star and shield
- Metal clip

7352
BADGE HOLDER

- Shaped for shield-style badges

L830
PLAINCLOTHES BELT 1.5” (38MM)

- SafariLaminate™ construction with a vegetable tanned leather support to accommodate holsters for larger handguns
- Available in Plain Black with solid brass or chrome buckle



572



573



590



7350



7352



L830



SAFARILAND® RANGE KIT

PROFESSIONAL EYE & EAR PROTECTION

- Kit includes: HD glasses, (1) pair of ear plugs with case, (1) passive headset
- High noise reduction rating
- High quality ear seals
- Color: Gun Metal Grey



SAFARILAND®

ELECTRONIC HEARING PROTECTION

- Electronic Noise Compression technology - sound compressed and reduced to safe hearing levels
- Features sound localization for maximum situational awareness and sound detection
- Low distortion speaker technology for superior sound quality
- 325-hour run time with 2 x AAA batteries
- Proprietary Earcup design layered with sound barrier technology; offered in Black
- Single-sided controls
- Rubber cheek wells

Hearing Protection



LIBERATOR® HP ADVANCED HEARING PROTECTION

- First of its kind multi-mode headset: Electronic Noise Compression and Active Noise Cancellation
- Provides enhanced hearing protection in all environments, while advanced sound localization provides maximum situational awareness and threat detection
- Dual Fuel technology which enables the headset to run on either two AAA or one CR123 battery
- 100-300-hour run time (mode dependent)
- Proprietary high definition speakers and speaker enclosures
- Modular headset suspension, user adjustable to be either over-the-head or behind-the-head for maximum comfort
- Proprietary Earcup design layered with sound barrier technology
- Available in Black w/Red and FDE Brown



075-2 HEARING PROTECTION HOLDER

- Clips on to belt
- Available in Black

33
dB
NOISE REDUCTION RATING



IN-EAR IMPULSE HEARING PROTECTION IN-EAR PROTECTION

Helps guard against hearing damage caused by automatic fire and single gun shots, artillery fire and explosions, reducing them to safe levels, less likely to cause long term damage.

- Automatically engages to protect hearing
- Still allows for ambient audio
- Proprietary material for long wear comfort
- Includes key chain aluminum transport/storage case
- No batteries required
- Two sets of ear inserts included: (2) medium and (2) large



Light Systems

Safariland® brings innovative designs to today's light systems. The popular Rapid Light System offers a quality hand-held light and a weapon-mounted light all in one.

RLS™ RAPID LIGHT SYSTEM

1. Ambidextrous
2. Super-bright LED technology (190 lumens) – bright enough to be your primary light. Prism Reflector System penetrates light up to 350 ft.
3. Uses three AAA batteries – no expensive proprietary batteries needed
4. Integral clip for easy securement to belt or garment – no dedicated light mount holster required
5. Fits most handgun models that incorporate an integral rail system – also mounts to rifles and shotguns that have a Picatinny rail
6. Quickly transitions from standard flashlight to tactical illumination
7. Can be operated with either thumb, or change to other side to operate with trigger finger. Push button provides controllable on/off illumination of target to minimize loss of handgrip, sight picture and exposure
8. RLS™ mount will accommodate most hand-held compact lights in the range of .970 (24.6mm) - 1.060 (26.9mm) in diameter

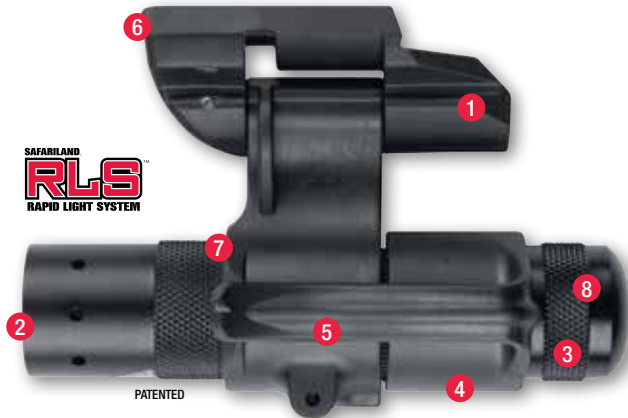

Easily and securely attaches to waistband or belt with integral clip



Push-button illumination



Slide RLS onto Tactical Rail



Lock RLS into place with a quick upward motion



Three AAAs provide over 40 hours' use



PATENT PENDING

RRL ROGERS RAIL LITE

- Ambidextrous design fits on any 1913 rail
- Tail on/off switch is positioned right at shooters forward thumb
- Easy snap on and off installation
- Made of a heavy-duty polymer yet is extremely lightweight
- External rib design for added strength and grip
- Streamlight® Microstream® 28 lumen flashlight included



RLSM MOUNT FOR DUTY BELT

- Provides a small mounting platform on duty belt to attach the RLS™ light
- Will also accommodate any light, laser, or other accessory that will fit on a Picatinny or light rail
- Fits belt widths up to 2.25" (58mm)
- Also fits on leg shroud, MLS or ELS Locking Fork
- Included with RLS

PATENTED

RLSR RLS™ REDUCTION SLEEVE

- Enables the RLS™ mounting system to be used with lights of both .90" and .80" diameters
- Slides inside RLS mount to easily accept narrower lights



(RLS™ shown with SureFire®)





PATENTED

014
OPEN CLASS COMPETITION HOLSTER

- Body machined out of aluminum to stabilize the handgun, yet offers little resistance for a secure and fast draw
- Ball joint on holster allows complete freedom of movement to customize the handgun draw
- Fully adjustable nosepiece accommodates barrels from 5" to 7.5" (13cm – 19cm)
- Fits a variety of competition handguns, with or without red dot or magnified optics
- Injection-molded adjustable trigger guard lock
- Front nosepiece designed to retain handgun and help prevent gun from being knocked out of the holster once seated
- Incorporates a simple push lock which secures weapon into the trigger block
- Also available for Glock, S&W and M&P
- Available in Black or Red finishes



002
CUP CHALLENGE COMPETITION HOLSTER

- Features dual-tension screws on the holster body, one in back of cylinder and the other in back of barrel, allowing a balanced retention of the handgun
- Loop lined belt tab provides a firm and adjustable carry when used with the Safariland Model 032 hook-lined competition belt
- Accommodates both scoped and non-scoped revolvers as well as most revolvers with standard, heavy, and slab side barrels
- Built-in removable muzzle strap protects front sights
- Available in STX Tactical® or STX Basketweave finishes



5197
RANGE SERIES OPEN TOP MID-RIDE HOLSTER

- Adjustable belt loop eliminates common belt-bulging and does not interfere with draw
- Compact and lightweight
- Detent in trigger guard for reliable weapon security
- Low-cut sides for ease of draw and added comfort
- Available in 1.5" (38mm) or 1.75" (45mm belt widths)
- Belt loop is user adjustable for cant angle; can even be worn cross draw
- IDPA approved
- Genuine SafariLaminate™ thermoformed construction
- Available in STX finishes including red

Legal for the following divisions: Bianchi Cup Open Division, Steel Challenge Limited and Open Division, USPSA Open, Limited, & Limited-10 and USPSA Multi-Gun All Divisions

Competition Accessories



USPSA KIT
USPSA KIT

- Ball joint on kit allows complete freedom of movement to customize the handgun draw
- Adjustable height bar for personalized holster height
- Designed to fit 1.5" (38 mm) to 1.75" (45 mm) belt widths and locks down with set screws
- Designed for use with Model 5197 Concealment Holster



014
014 ADAPTER

- Allows for various mounting options for the 014 holster
- Available in Black



030
BUCKLELESS™ COMPETITION UNDERBELT 1.5" (38MM)

- Loop on outer side to connect to model 032
- Available in Black with web finish



334
RIGID COMPETITION BELT 1.5" (38MM)

- Reinforced to hold heavy competition handguns and ammunition
- Single Safariland® branded keeper
- Hook liner for use with Safariland 030 underbelt (like on 032)



776
COMPETITION MAGNETIC MAGAZINE HOLDER

- Magazines are oriented "bullets out" to save space on belt
- Designed with internal magnets to be used as a tension device
- Durable nylon construction with hook and loop closure
- Includes a snap loop attachment to hold flap in place
- Available with 744BL Belt Clip or ELS 34 Locking fork



032
ELS COMPETITION BELT 1.75" (45MM)

- Reinforced to hold heavy competition handguns and ammunition
- Hook lined to attach to 030 underbelt
- Pre-cut holes to mount ELS 35 Receiver Plates in multiple locations and angles
- Available in Nylon Look and Basketweave finishes



332
RANGE BELT 1.5" (38MM)

- Reinforced to hold heavy competition handguns and ammunition
- Highly tactile interior to grip clothing
- Available in Cordura® nylon, Black, Coyote Brown, Khaki Ranger Green

Competition Accessories

CONCEALABLE ARMOR | TACTICAL ARMOR | COMMUNICATIONS | DUTY GEAR/HOLSTERS | PROTECTIVE GEAR | ACCESSORIES | FIREARMS | LESS LETHAL | PERFORMANCE APPAREL | SURVIVABILITY SYSTEMS | FORENSICS | ARMOR SYSTEMS | TRAINING ACADEMY



4555

SHOOTERS' RANGE BAG

- Removable center carry compartment has zippered, padded side panels for four separate handgun compartments
- Magazine pouches sewn into main storage area
- Two large exterior pockets and a fully lined interior
- Overall dimensions: 14" x 9" x 10"

SEE MORE ON PAGE 82



NEW

4559

SHOOTERS' RANGE BACKPACK

- Rugged ballistic pack cloth construction
- Assorted compartments and dividers to store and organize your shooting gear
- Heavy-duty lockable zippers
- Reinforced large lower compartment for heavy ammunition
- Removable dual pistol sleeve
- Includes an all-weather cover
- Available in Black and Tan

NEW



4566

ENHANCED 3-GUN BAG

- Heavy-duty lockable zippers, two adjustable outside accessory pouches
- Large dual handgun/accessory pouch with individual hook and loop enclosed handgun storage areas, and four pistol mag pouches large enough for extended magazines
- Closed-cell protective foam padding and 2" perimeter lip
- Assorted accessory pockets inside case
- Adjustable padded shoulder harness for shoulder carry
- Includes adjustable backpack-style carry straps that tuck away in storage pocket when not in use
- Unique zippered barrel expansion slot on side of case can be opened to allow use of longer firearms (up to 55")
- 51" overall length (with expansion slot closed)

SEE MORE ON PAGE 83



774

RIFLE MAGAZINE POUCH

- FDE Brown or Coyote Brown finishes

SEE MORE ON PAGE 82



773M

COMPETITION MAGAZINE POUCH WITH MAGNET

- Two magazine tensioning screws on back side of holster to adjust tension on both middle and end of magazine
- Contains super-strong pick-up magnet



771/773

OPEN TOP SINGLE MAGAZINE POUCH

- Features two magazine tensioning screws on back side of the holster to adjust tension on both the middle and end of the magazine
- Built-up channel for clearance of the bullet during the draw
- Available in STX Tactical or STX Basketweave finishes

Competition Accessories

086

SHOTGUN SHELL HOLDER

- Holds (2), (4), (6) or (8) 12-Gauge shotgun shells
- Unique retaining plate keeps the shotgun shells from dislodging, and are quickly removed a few at a time or all at once
- Sturdy aluminum back plate allows for ride height and cant adjustments
- Available with ELS 34 Locking Fork or 745BL Belt Clip



PATENT PENDING



080-12

PATENT PENDING

080-12

SHOTGUN SHELL HOLDER

- Molded shotgun shell holder holds (2) 12-Gauge shells
- Belt clip features an extended bottom hook for security
- Fits belts up to 2.25" (58mm) wide

085

QUAD SHOTGUN SHELL HOLDER

- Provides (4) 12-Gauge shells when needed
- All shells can be grasped and employed at once
- Available on an ELS 34 Locking Fork, 744BL Belt Clip, ELS 34/ELS 35 Locking Fork and Plate combo, or plain for direct leg shroud mounting
- Tensioners provide solid retaining system to hold shells, even when some are removed on model 085
- For use with 2 3/4" shells



6005-12

SHOTGUN SPEEDLOADER HOLDER

- Designed to be worn on the thigh
- Provides quick access to up to five shotgun speedloaders
- Cup and retention clip system keeps loaders stable, even while running
- Includes ELS 34 Fork on leg strap to work in conjunction with 032 ELS Competition Belt or can also be used with conventional competition belts using existing belt loop



PATENT PENDING

COMP I / II / III

SPEEDLOADER

- Injection-molded construction
- Large-frame versions offer maximum grip clearance



COMP I

COMP II

COMP III

Safariland Accessories

**HARDWARE KIT**

- Kit provides the necessary materials: screws, rollers, washers, T-nuts, hook, and Allen wrench to service Safariland holsters

**TS-9250/9255****SAFARILAND® HAT**

- Adjustable size fits all
- Low-profile design
- Embroidered logo on front and Safariland on back and on edge of bill
- Available in Black and Tan

**DVD****TRAINING DVDs**

- Wide selection of informative training DVDs available



BACK

TS-2900**SAFARILAND® LONG SLEEVE PERFORMANCE SHIRT**

- Team Safariland competition long-sleeved shirt
- Moisture-wicking fabric helps keep the wearer cool in hot environments and warm in cold ones
- Black with silk-screened Safariland logo on front, back and forearms
- Available in sizes S-XXL

**TS-3200****SAFARILAND® PERFORMANCE T-SHIRT**

- Moisture-wicking fabric helps keep the wearer cool in hot environments and warm in cold ones
- Black or Grey with silk-screened Safariland logo on upper front chest and upper back
- Available in sizes S-XXL

**TS-6600/TS-6610****SAFARILAND® MEN'S / WOMEN'S PERFORMANCE POLO SHIRT**

- Moisture-wicking fabric helps keep the wearer cool in hot environments and warm in cold ones
- Black with embroidered Safariland logo on upper left chest
- Available in sizes S-XXL

**TS-6600****SAFARILAND® MEN'S PERFORMANCE POLO SHIRT**

- 100% polyester wicks away perspiration to keep you cool in the heat and warm when it's cold
- Safariland logo on chest of shirt
- Available in White
- S-XXL

**SAF-CUP-MUG**
COFFEE MUG

- Matte Black finish with Safariland logo in red and liquid gold on both sides
- Ceramic
- 17 oz. capacity

**SAF-CUP-2**
COFFEE TUMBLER

- 16 oz. stainless tumbler with Matte Black finish
- Safariland logo printed in red and liquid gold on one side

**SAF DECAL**
SAFARILAND DECAL

- Small 3" x 3"
- Large 6" x 6"

BIANCHI

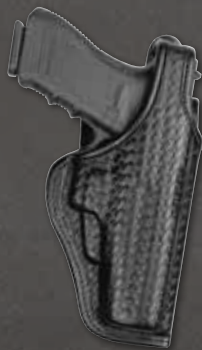

I D U T Y G E A R



BIANCHI



Celebrating more than 60 years, Bianchi® products are recognized by shooting enthusiasts and professionals the world over. The Bianchi hallmarks of handcrafted workmanship, innovative yet functional design and quality are just as strong today as they were in 1958, when John Bianchi built his first leather holster in his garage. To this day, the focus remains on providing customers with the best combination of innovation and handcrafted, time-tested designs.

Materials/Technology

Bianchi® offers a variety of materials to meet the needs of those who use our products. From AccuMold® ballistic weave to leather and leather/laminate combinations, Bianchi has a material that works for you. Our premium grade full grain leather and ballistic weave fabrics are long lasting, durable, and offer the professional look desired by law enforcement and sports enthusiasts alike.



AccuMold®

A state-of-the-art molded synthetic product of trilaminate construction - ballistic weave outer fabric, a firm, high-density closed-cell foam center; and a smooth Coptex™ lining. AccuMold® pouches are contour-molded to precisely fit the gear it was designed to carry.



AccuMold™ Elite

We've taken our patented AccuMold technology and dressed it up. The AccuMold® Elite™ line offers the same construction of AccuMold, but with a Duraskin™ outer material that looks amazingly like leather. You can't tell the difference until you pick it up and see that it's almost half the weight.



PatrolTek™

PatrolTek™ duty belts and accessories are made using our molded trilaminate technology but at a price to meet the demands of ever-tightening budgets. You don't have to give up function and wear to get duty gear at a great price.

COLORS AND FINISHES

ACCUMOLD



BALLISTIC WEAVE

ACCUMOLD ELITE



DURASKIN™ PLAIN



DURASKIN™ BASKET



DURASKIN™ HI GLOSS

PATROLTEK



600-DENIER WOVEN

LEATHER



PLAIN TAN



PLAIN BLACK



Design, function, security, and comfort have always been at the forefront when developing new Bianchi products. Our research and development team continually focuses on new materials and new technologies to offer the best in the industry.



ALLUSION™ SERIES



The Bianchi® Allusion™ series brings you the best of leather and synthetic materials for superior performance and good looks. We start out with a thermoformed, synthetic shell precisely formed to the firearm. Then we wrap it with our premium grade, full grain, vegetable tanned cowhide and give it our finishing touches, including burnished edges and our leather dressing that gives the holster that distinctive leather look and smell. With the Allusion series, we are also able to add features not typically found with leather-only construction, such as our retention detent, smooth draw and re-holstering.

The Allusion series perfectly matches tradition and cutting edge technology, bringing leather holsters into the 21st century.

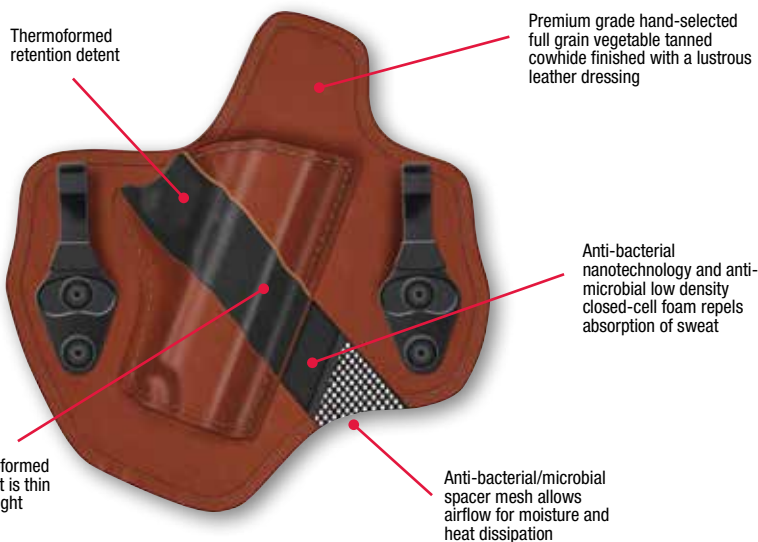

BIANCHI GUNLEATHER®

Many people love traditional leather. It wears beautifully, and nothing quite smells or feels the same. Bianchi leather is full-grain cowhide – the best available. We choose different weights based on the product requirements, handcrafting and molding it to perfection the old-fashioned way, by not cutting corners.

- We use full grain premium cowhide
- Sewing process uses a lock-stitch for quality and durability



Bianchi® offers a variety of materials to meet the needs of those who use our products. From AccuMold® ballistic weave to leather and leather/laminate combinations, Bianchi has a material that works for you. Our premium grade full grain leather and ballistic weave fabrics are long lasting, durable, and offer the professional look desired by law enforcement and sports enthusiasts alike.



PINCH® RETENTION DEVICE – PRD™

Our exclusive PRD is formed of a high strength polymer. When the weapon is firmly seated in the holster, the PRD grips the trigger guard, holding the weapon in place until you're ready to draw.

AccuMold®

7105

CRUISER™ DUTY HOLSTER

- A hi-ride duty holster that positions pistol close to the body
- Top-draw design
- Made with 50% greater density foam than standard civilian AccuMold® holsters, for firmness and strength
- Unique Coptex™ inner lining helps protect gun finish and provides a smooth draw
- Quick-Slide™ injection-molded belt loop fits up to 2.25" (58mm) belts
- Available in Black Ballistic Weave finish



AccuMold®

7120

DEFENDER® DUTY HOLSTER

- Top-draw holster with mid-ride and traditional metal reinforced thumb snap closure
- Pinch® Retention Device (PRD™) enhances firearm retention by gripping the pistol's trigger guard
- Unique Coptex™ inner lining helps protect gun finish and provides a smooth draw
- Metal reinforced 2.25" (58mm) jacket slot belt loop, curved for comfort
- Available in Black Ballistic Weave finish



AccuMold® Elite

7920

DEFENDER® II DUTY HOLSTER

- Top-draw holster with mid-ride carry and metal reinforced thumb snap closure
- Contour-molded, trilaminate construction with 50% greater density foam than civilian AccuMold® holsters
- Internal Pinch® retention device grips the pistol's trigger guard
- Soft Coptex™ poly-knit inner lining
- Metal reinforced 2.25" (58mm) jacket slot belt loop, curved for comfort
- Available in Plain Black, Basketweave Black and Hi Gloss Duraskin™ finish



AccuMold®

7115

VANGUARD™ DUTY HOLSTER

- Straight drop duty holster with mid-ride and top-draw molded internal Tension™ Strips
- Contour-molded, trilaminate construction with 50% greater density foam than civilian AccuMold® holsters
- Metal reinforced thumb snap closure
- Soft Coptex™ poly-knit inner lining
- Metal reinforced 2.25" (58mm) jacket slot belt loop, curved for comfort
- Available in Black Ballistic Weave finish



Duty Belts

- Equipment belts are constructed with either four-part or five-part laminate for long-lasting shape and exceptional durability. Four-part laminate features a firm polyethylene center strip sandwiched between a high-density, closed-cell foam, with a durable nylon lining, and either a weave or Duraskin™ exterior depending on the model
- ErgoTek belts uniquely designed to spread weight of loaded duty belt over entire waist
- CopLok polymer buckles are shatter-resistant with a 3-point release for extra security

AccuMold®



7200 DUTY BELT - LOOP 2.25" (58MM)

- Five-part laminate construction
- Ballistic weave fabric exterior with loop lining
- CopLok buckle



PATENTED

7225 ERGOTEK™ DUTY BELT 2.25" (58MM)

- Five-part laminate construction
- Load support cushions on inner lining distribute weight of duty belt over entire waist for comfort during the entire shift
- Ballistic weave fabric with loop lining for use with Bianchi® 7205 Liner Belt
- Accepts standard holsters and pouches
- CopLok buckle

**AccuMold™
Elite**



7950 DUTY BELT 2.25" (58MM)

- Four-part laminate construction
- Duraskin™ exterior with loop lining for use with Bianchi® 7205 Liner Belt
- CopLok buckle



PATENTED

7965 ERGOTEK™ SAM BROWNE BELT 2.25" (58MM)

- Four-part laminate construction
- Load support cushions on belt lining spread weight of gear over entire waist
- Provides a padded buffer between stiff outer belt with accessories and the wearer
- Duraskin™ exterior with loop lining for use with Bianchi® 7205 Liner Belt



7203 NYLON DUTY BELT - HOOK 2.25" (58MM)

- Five-part laminate construction
- Ballistic weave fabric exterior with hook lining
- CopLok buckle



7215 NYLON DUTY 2.5" (58MM)

- Five-part laminate construction
- Ballistic weave fabric exterior with hook lining
- AustriAlpin Cobra buckle



7216 NYLON DUTY 2.0 (50MM)

- Five-part laminate construction
- Ballistic weave fabric exterior with hook lining
- AustriAlpin Cobra buckle
- Rescue Loop



PATENTED

7955 ERGOTEK™ DUTY BELT 2.25" (58MM)

- Four-part laminate construction
- Duraskin™ exterior with loop lining for use with Bianchi® 7205 Liner Belt
- Load support cushions on inner lining spread load of duty belt over entire waist
- CopLok buckle



7970 BUCKLELESS™ DUTY BELT 2.25" (58MM)

- Four-part laminate construction
- Positive 3-way retention using hook and loop, retaining stud and belt keeper
- Duraskin™ exterior with loop liner for use with Bianchi® 7205 Liner Belt



7210 DUTY BELT 2" (50MM)

- Five-part laminate construction
- Ballistic weave fabric exterior with loop lining
- CopLok buckle



PATENTED

7220 DUTY BELT 2" (50MM)

- Ballistic weave nylon with full-length hook lining
- Both ends are skived, allowing a lower profile around the buckle
- CopLok buckle



7235 DUTY BELT SYSTEM 2.25" (58MM)

- Five-part laminate construction
- Ballistic weave fabric exterior with loop lining
- Includes duty belt, liner, and 4 attached keepers
- CopLok buckle



7960 SAM BROWNE BELT 2.25" (58MM)

- Four-part laminate construction
- Duraskin™ exterior with loop lining for use with Bianchi® 7205 Liner Belt
- Load support cushions on inner lining spread load of duty belt over entire waist



7980 DUTY BELT 2" (50MM)

- Four-part laminate construction
- Duraskin™ exterior with loop lining for use with Bianchi® 7205 Liner Belt
- CopLok buckle

CONCEALABLE ARMOR | TACTICAL ARMOR | COMMUNICATIONS | DUTY GEAR/HOLSTERS | PROTECTIVE GEAR | ACCESSORIES | FIREARMS | LESS LETHAL | PERFORMANCE APPAREL | SURVIVABILITY SYSTEMS | FORENSICS | ARMOR SYSTEMS | TRAINING ACADEMY

Duty Belts

PatrolTek™ LEATHER



- B2**
SAM BROWNE BELT 2.25" (58MM)
- Highest grade full grain leather
 - Unlined



- B8G**
GARRISON BELT 1.75" (45MM)
- Heavyweight, full grain leather
 - Unlined
 - Garrison style buckle
 - Nickel or brass finish buckle
 - Solid brass or chrome plated brass buckle



- B5**
DRESS BELT 1.5" (38MM)
- Full grain leather
 - Perfect for casual or dress
 - Unlined
 - Solid brass or chrome plated brass buckle

PatrolTek™



- 8100**
WEB BELT 2" (50MM)
- Loop lined for use with 8105 Liner Belt
 - Tough, double-layered web construction
 - Smooth, edge-bound finish for extra comfort
 - CopLok buckle



- 8110**
WEB BELT WITH HOOK LINING 2" (50MM)
- Hook lined for use with 8106 Liner Belt
 - Tough, double-layered web construction
 - Smooth, edge-bound finish for extra comfort
 - CopLok buckle



- 8300**
DUTY BELT SYSTEM 2" (50MM)
- Hook and loop lining
 - Tough, double-layered web construction
 - Includes duty belt, liner and 4 attached keepers
 - CopLok buckle



- 8105**
LINER BELT - HOOK 1.5" (38MM)
- Hook surface for use with 8100 Duty Belt
 - Tough web construction
 - Hook and loop closure for quick on/off ease



- 8106**
LINER BELT - LOOP 1.5" (38MM)
- Loop surface for use with 7203 Duty Belt
 - Tough web construction
 - Hook and loop closure for quick on/off ease



- 7205**
LINER BELT 1.5" (38MM)
- Hook and loop closure for quick on/off ease
 - Lined with hook



- 7201**
TRAINING, HOOK AND LOOP BELT 1.75" (45MM)
- Four-part laminate construction
 - Hook and loop closure for quick on/off ease



- 7221**
BALLISTIC BELT 2" (50MM)
- Ballistic weave trilaminate construction
 - Both ends are skived for a lower profile around the buckle
 - CopLok shatter-resistant, polymer buckle features 3-point release for added security
 - Available in FDE Brown, OD Green, Foliage Green, or Black finishes



- 7202**
GUN BELT 1.75" (45MM)
- Four-part laminate construction
 - Shatter-resistant polymer buckle



AccuMold®

- This Bianchi® technology features a method of molding to contour the laminate to the exact shape of the equipment it will carry
- Its trilaminate construction features a ballistic weave fabric exterior with a high-density, closed-cell foam center and a smooth Coptex™ knit lining
- Magazine pouch cavities expand both front and rear, making for a snugger fit, a trimmer look and less strain on the equipment
- These pouches feature our exclusive Roll Top™ lid for a smooth, rounded closure and a custom fit for equipment of various sizes
- All molded accessories feature the dual molded belt loop to fit both 2" (50mm) and 2.25" (58mm) belt widths unless otherwise noted
- Reinforced hidden snap or hook and loop closure
- Certain models available with MOLLE loops



7301
SPEEDLOADER POUCH

- AccuMold® trilaminate with ballistic weave exterior and Coptex™ lining



7302
DOUBLE MAGAZINE POUCH

- Injection-molded belt loop for horizontal or vertical carry
- Hook and loop or hidden snap closure
- Available with MOLLE straps



7303
SINGLE MAGAZINE POUCH

- Hook and loop or hidden snap closure
- Available with MOLLE straps



7320
**TRIPLE THREAT™ II
DOUBLE MAGAZINE POUCH**

- Injection-molded belt loop for vertical or horizontal carry
- Tension screw adjustment permits various drawing angles
- Fits 2.25" (58mm) belt widths



7335
EDW SINGLE POUCH

- Holds one Taser® X26P cartridge



7336
EDW SINGLE POUCH

- Holds two Taser® X26P cartridges



7300

COVERED HANDCUFF CASE

- Two sizes hold one pair chain or hinged handcuffs
- Hook and loop or hidden snap closure
- Available with MOLLE strap

7334

OPEN TOP HANDCUFF CASE

- Holds one pair chain handcuffs

7317

DOUBLE HANDCUFF CASE

- Holds two pair standard chain handcuffs
- Hook and loop or hidden snap closure
- Available with MOLLE straps



7318

ULTIMATE HINGE HAND CUFF CASE

- Holds one pair Hiatt® 8142 cuffs
- Hook and loop or hidden snap closure

7307

MACE®/OC SPRAY HOLDER

- Two sizes for MK-2, MK-3 and MK-4 canisters
- Hook and loop or hidden snap closure
- Available with MOLLE strap

7308

OPEN TOP MACE®/OC HOLDER

- Three sizes fit MK-2, MK-3 and MK-4 canisters

7310

MINI-LIGHT HOLDER

- Fits AA-cell lights
- Hook and loop or hidden snap closure

7311

COMPACT LIGHT HOLDER

- Three sizes fit most compact lights
- Hook and loop or hidden snap closure

7312

EXPANDABLE BATON HOLDER

- Covered hole in back allows baton to be placed in pouch fully expanded
- Available with MOLLE strap

7326

COMPACT LIGHT HOLDER

- Three sizes fit most compact lights
- Hook and loop or hidden snap closure



Duty Pouches



7314
7314S



7324
7324S



ARS



7323



7405K



7405



7406



7315



7328



7316



7404



7409



7409K

7314/7314S

UNIVERSAL RADIO HOLDER

- Elastic security strap with snap closure
- Fits most hand-held radios
- 7314S features a two-piece adjustable swivel base and mount

7324/7324S

SLIMLINE RADIO HOLDER

- Holds compact hand-held radios
- Elasticized security strap
- 7324S features a two-piece adjustable swivel base and mount
- Available with MOLLE strap

7323

ADJUSTABLE RADIO HOLDER

- Holds compact hand-held radios
- Elasticized security strap

ARS

RADIO SWIVEL ATTACHMENT

- 2.25" (58mm) belt loop
- Sold separately for ease of transferring radios among users

7315

GLOVE HOLDER

- Holds most pocket pagers or two pair latex gloves
- Hook and loop or hidden snap closure

7328

FLAT GLOVE HOLDER

- Holds two pair latex gloves
- Hook and loop or hidden snap closure

7316

SILENT KEY HOLDER

- Roll Top™ wraparound design
- Hook and loop closure

7405/7405K

KEY HOLDER

- 1" web keeper with polymer key holder attached
- Sewn (7405) or dual snap (7405K) closure

7406

BELT KEEPER

- 1" web
- Dual-snap or hook and loop closure
- Sold in 4-pack

7404

BATON RING

- Fits standard and side-handle batons
- Sturdy, 1" web with injection-molded ring

7409/7409K

FLASHLIGHT RING

- Molded ring locks flashlight in place
- 1" web

Duty Pouches



- Lightweight – up to 50% lighter than leather in most applications
- More affordable than leather
- Improved comfort translates into better officer performance in the field
- Same beautiful look as leather – the crisp, professional appearance of premium leather without the weight, maintenance and cost
- Reinforced hidden snap closure unless specified otherwise
- Abrasion-resistant – exhibits a high level of resistance to the daily knocks, scuffs and abrasions of duty use
- Easily cleaned with only mild soap and water. Bio-safe: washing with disinfectant soap or bleach solution will handle contamination problems. Great for correctional institution duty
- All molded accessories feature the dual belt loop to fit both 2" (50mm) and 2.25" (58mm) widths unless otherwise noted



7902

7903

7915

7922



7935

7936



7900

7917

7918

7934

7902

DOUBLE MAGAZINE POUCH

- Vertical or horizontal carry
- Four sizes to fit most magazines
- Injection-molded belt loop
- Chrome, brass or hidden snap

7903

SINGLE MAGAZINE/KNIFE POUCH

- Three sizes fit most magazines
- Hidden snap

7915

GLOVE HOLDER

- Holds most standard pagers or two pair latex gloves
- Chrome, brass or hidden snap

7922

TRIPLE THREAT™ II DOUBLE MAGAZINE POUCH

- Injection-molded belt loop for vertical or horizontal carry
- Tension screw adjustment permits various drawing angles

7935

EDW SINGLE POUCH

- Holds one Taser® X26P cartridge

7936

EDW DOUBLE POUCH

- Holds two Taser® X26P cartridges

7900

COVERED HANDCUFF CASE

- Holds one pair chain or hinged handcuffs
- Chrome, brass or hidden snap

7917

DOUBLE HANDCUFF CASE

- Holds two pair chain handcuffs
- Chrome, brass, or hidden snap
- Dual web belt loop fits 2" (50mm) and 2.25" (58mm) belts

7918

ULTIMATE HINGE HANDCUFF CASE

- Holds one pair Hiatt® Model UL handcuffs or similar

7918

ULTIMATE HINGE HANDCUFF CASE

- Holds one pair Hiatt® Model UL handcuffs or similar

7934

OPEN TOP HANDCUFF CASE

- Holds one pair chain or hinged handcuffs



7926



7907



7908



7912



7911



7916



7906



7904



7909



7928



7914S



7923

7911
COVERED COMPACT LIGHT HOLDER

- Three sizes fit most compact lights; e.g., Streamlight® and SureFire®
- Chrome, brass or hidden snap

7926
COMPACT LIGHT HOLDER

- Two sizes fit most compact lights; e.g., SureFire® 6P, 6R; Streamlight® Stinger XT, Poly Stinger, Scorpion
- Slides on to 2.25" (58mm) belts

7907
MACE®/OC SPRAY HOLDER

- Two sizes for MK-2, MK-3 and MK-4 canisters
- Chrome, brass or hidden snap

7908
OPEN TOP MACE®/OC SPRAY HOLDER

- Three sizes for MK-2, MK-3 and MK-4 canisters
- Sturdy web belt loop

7912
EXPANDABLE BATON HOLDER

- Covered hole in back allows baton to be placed in pouch fully expanded

7928
FLAT GLOVE HOLDER

- Holds two pair latex gloves
- Hook and loop closure only
- 2.25" (58mm) belt loop

7916
SILENT KEY HOLDER

- Roll Top™ wraparound design
- Hook and loop closure

7914S
UNIVERSAL RADIO HOLDER

- Holds most hand-held radios
- Elasticized security strap with snap closure
- Two-piece adjustable swivel mount for comfort when riding in a vehicle

7923
ADJUSTABLE RADIO HOLDER

- Two sizes hold compact hand-held radios
- Elasticized security strap
- Slim design offers less bulk

7904
SIDE-HANDLE BATON HOLDER

- Fits straight and side-handle batons
- Sturdy, injection-molded ring
- One-way snap-on belt loop

7909
D-CELL LIGHT HOLDER

- Molded ring locks flashlight in place
- Snap-on belt loop

7906
BELT KEEPER

- Dual snap closure
- Sold in 4-pack
- 1" width; available in chrome, brass or hidden snaps

Duty Pouches

PatrolTek™

- With significant cost savings compared to premium brands, PatrolTek™ also offers the quality and functionality you've come to expect from Bianchi®
- Contour-molded technology
- Pleated pouch lids offer a smooth closure and great fit
- Reinforced hidden snap closure unless specified
- Trilaminar with 600-denier woven finish
- All molded accessories feature the dual belt loop to fit both 2" (50mm) and 2.25" (58mm) widths unless otherwise noted
- Lightweight and weatherproof
- Easily cleaned with soap and water
- Stays flexible in cold weather



8002



8020



8036



8015



8016



8003



8035

8002

DOUBLE MAGAZINE POUCH

- Vertical or horizontal carry

8003

SINGLE MAGAZINE POUCH

- Four sizes to fit most magazines
- Hook and loop or hidden snap closure

8020

TRIPLE THREAT™ II DOUBLE MAGAZINE POUCH

- Injection-molded belt loop for vertical or horizontal carry
- Tension screw adjustment permits various drawing angles

8035

EDW SINGLE POUCH

- Holds one Taser® X26P cartridge

8036

EDW DOUBLE POUCH

- Holds two Taser® X26P cartridges

8015

GLOVE HOLDER

- Holds most standard pagers or two pairs latex gloves

8016

SILENT KEY HOLDER

- Wraparound hook and loop closure





8000



8017



8018



8034



8038S



8001



8010



8011



8026

8000
COVERED HANDCUFF CASE

- Holds one pair chain or hinged cuffs
- Hidden snap closure

8017
DOUBLE HANDCUFF CASE

- Holds two pairs chain handcuffs
- Hook and loop closure

8018
ULTIMATE HINGE HANDCUFF CASE

- Holds one pair Hiatt® Model 8142 cuffs
- Hook and loop or hidden snap closure
- Dual web belt loop fits 2" (50mm) and 2.25" (58mm) belts

8034
OPEN TOP HANDCUFF CASE

- Pull-through style
- Holds one pair chain cuffs

8038S
RIGID HANDCUFF CASE

- Holds one pair Hiatt® Model 8132 Rigid Cuff or similar
- Adjustable swivel mount

8001
SINGLE HANDCUFF CASE WITH KEY SLOT

- Holds one pair chain or hinged cuffs
- Slot to hold spare cuff key in lid

8010
MINI-LIGHT HOLDER

- Fits AA-cell lights
- Hook and loop or hidden snap closure

8011
COMPACT LIGHT HOLDER

- Hidden snap closure
- Full flap helps secure light

8026
COMPACT LIGHT HOLDER

- Two sizes fit most 1" diameter lights

Duty Pouches



8006



8006I



8007



8008



8009



8012



8013S



8028



PATENTED
8014
8014S

8006

BELT KEEPER

- 1" web
- Black finished brass snaps
- Sold in 4-pack

8006I

SLIDE-ON BELT KEEPER

- 1" web
- Keeps duty belt secure to liner belt
- Black finished brass snaps

8007

MACE®/OC SPRAY HOLDER

- Two sizes for MK-2, MK-3 and MK-4 canisters

8008

OPEN TOP MACE®/OC SPRAY HOLDER

- Three sizes for MK-2, MK-3 and MK-4 canisters
- Open-top design for quick access

8009

FLASHLIGHT RING

- 1" web
- Molded plastic ring locks flashlight in position
- Fits D-cell lights
- Available in sewn or snap version

8012

EXPANDABLE BATON HOLDER

- Baton holder w/ hole in back for reholstering expanded baton
- Three sizes to fit 16", 21" and 26" Monadnock® and similar batons

8013S

EXPANDABLE BATON HOLDER WITH SWIVEL

- Adjustable swivel mount
- Can be used with Monadnock® Wedge™ Cap
- 2" (50mm) width belt loop

8014/8014S

UNIVERSAL RADIO HOLDER

- Holds most hand-held radios
- Adjustable elastic security strap with snap closure
- 8014S features a two-piece adjustable swivel base and mount

8028

FLAT GLOVE HOLDER

- Holds two pairs of latex gloves
- Trim and compact

PatrolTek™
LEATHER

- Bianchi® design and quality at a value price
- Durable construction for the rigors of daily use
- Full line of essential duty accessories
- Available in Plain or Basketweave finish with chrome, brass, or hidden snap hardware



20C



29



31



31C



32A



32P



33



35P



36A



37BL



37M



37S

20C

DOUBLE MAGAZINE POUCH

- Vertical or horizontal carry
- Two sizes for most 9mm/.40, or .45 single stack magazines
- Chrome, brass or hidden snaps

29

TRIPLE THREAT™ MAGAZINE POUCH

- Vertical or horizontal carry
- Two sizes for most 9mm/.40, or .45 single stack magazines
- Chrome, brass or black snaps

31

KEY FLAP

- Wide flap eliminates key wear on clothing
- Chrome, brass or black snaps

31C

SILENT KEY HOLDER

- Keeps key quiet
- Hook and loop closure
- Chrome, brass or black snaps

32A

EXPANDABLE BATON HOLDER

- Available for both 21" and 26" batons
- One-way directional snap for strength

32P

BATON HOLDER

- Available for both 21" and 26" batons
- One-way directional snap for strength
- Chrome, brass or black snaps

33

BELT KEEPER

- Full 1" wide
- Chrome, brass or black snaps
- Sold in 4-pack

35P

HANDCUFF CASE

- Holds linked or hinged cuffs
- Chrome, brass or hidden snaps

36A

MACE®/OC SPRAY POUCH

- Available for MK-4 canisters
- One-way directional snap for strength
- Chrome, brass or hidden snaps

37BL

D-CELL LIGHT HOLDER

- Molded ring holds flashlight in place
- One-way directional snap for strength
- Chrome, brass or black snaps

37M

MINI LIGHT HOLDER

- Fits AA-cell lights
- Snap-on belt loop

37S

COMPACT LIGHT HOLDER

- Two sizes to fit most compact flashlights
- Slide-on belt loop



ALLUSION™

The Bianchi® Allusion series is the best of leather and synthetic materials for superior performance and good looks. We start out with a thermoformed, synthetic shell precisely formed to the firearm. Then we wrap it with our premium grade Bianchi Gunleather® and give it our finishing touches, including burnished edges and our leather finish.

- Premium full grain leather exterior with a laminate synthetic liner for a smooth draw and long lasting wear

BELT SLIDE



126
ASSENT™

- Open-top design for quick draw and easy re-holster
- Trigger guard detent for enhanced weapon retention
- Dual belt loops fit 1.5" (38mm) belt widths



131
CONFIDENTIAL™

- Thumb break strap and trigger guard detent for enhanced weapon retention
- Dual belt loop fits 1.5" (38mm) belt widths



140
REVEAL™

- Thumb break strap for enhanced weapon retention
- Specifically designed to fit weapons with gun mounted lights
- Dual belt slots fit up to 1.5" (38mm) belts for better, tighter fit with belt
- Available in Plain Tan, Plain Black, Basketweave Tan, or Basketweave Black finish

Allusion Concealment Holsters

INSIDE WAIST



145

SUBDUE™ IWB

- Premium full grain leather exterior with a laminate synthetic liner for a smooth draw and long lasting wear
- Heavy-duty spring-steel belt clip securely anchors holster to belt or trousers
- Anti-bacterial and anti-microbial foam padding on inside liner of leather backing to prevent germs and odor from accumulating against the body
- Padded liner provides added comfort not normally found on bare leather designs
- Slight detent in trigger guard for enhanced weapon retention
- Fits up to 1.75" (45mm) belt widths
- Available in Plain Black finish



135

SUPPRESSION™ IWB

- Premium full grain leather exterior with a laminate synthetic liner for a smooth draw and long lasting wear
- Dual tuckable J-Hook design for attachment to the belt provides strong belt retention on the holster while also minimizing its visibility
- Anti-bacterial and anti-microbial foam padding on inside liner of leather backing to prevent germs and odor from accumulating
- Padded liner provides added comfort not normally found on bare leather designs
- Slight detent in trigger guard for enhanced weapon retention
- Fits up to 1.5" (38mm) belt widths
- Available in Plain Tan or Plain Black finish

155

SUBVERSION™ IWB HOLSTER

- Premium full grain leather exterior with a laminate synthetic liner for a smooth draw and long lasting wear
- Belt retention strap wraps under belt and offers adjustability for cant
- Anti-bacterial and anti-microbial foam padding on inside liner of leather backing to help prevent germs and odor from accumulating against the body
- Padded liner provides added comfort not normally found on bare leather designs
- Slight detent in trigger guard for enhanced handgun retention
- Fits up to 1.75" (45mm) belt widths
- Available in Plain Black finish

Concealment Holsters

BELT SLIDE



57
REMEDY™

- Open-top for quick access and draw; ideal for rear hip carry
- Deeply molded contours on front of holster for comfortable fit and classic good looks
- Dual belt slots fit up to 1.5" (38mm) belts for better, tighter fit with belt
- Low-profile, hi-ride design effectively conceals firearm with minimal bulk
- Available in full grain leather, Plain Tan or Plain Black finish



58
P.I.™

- Open-top for quick access and draw with a low-profile, compact design
- Heavy 30° cant for hip carry
- All molding to the front of the holster, providing more comfortable fit for wearer
- Low-profile, ultra hi-ride design effectively conceals firearm with minimal bulk
- Dual belt slots fit up to 1.5" (38mm) belts for better, tighter fit with belt
- Available in full grain leather, Plain Tan or Plain Black finish



56
SERPENT™

- Reinforced, rectangular thumb snap for quick snap release and helps guard against strap falling into trigger guard when re-holstering
- Deeply molded contours on front of holster for comfortable fit and classic good looks
- Dual belt slots fit up to 1.5" (38mm) belts for better, tighter fit with belt
- Available in full grain leather, Plain Tan or Plain Black finish



7
SHADOW® II

- Ultra hi-ride for excellent concealability
- Three-slot design allows user to vary the carry angle for his/her preference
- Strongside or cross draw carry, open muzzle design
- Molded and pre-curved to fit the body for maximum comfort
- Fits up to 1.75" (45mm) belt width
- Available in full grain leather, Plain Tan or Plain Black finish



BELT SLIDE



105

MINIMALIST™ WITH SLOTS

- A compact, open-top design ideal for daily wear
- Features elastic loop retainer tab for secure retention
- Belt slide design provides excellent stability for weapon
- Slots designed to pull firearm in close to the hips for optimum concealment
- Suede lined; fits belt widths up to 1.75" (45mm)
- Available in full grain leather, Plain Tan or Plain Black finish



55L

LIGHTNIN®

- Designed specifically for hammerless revolvers
- Finger-snap strap crosses behind trigger guard for a middle finger release
- Fully suede lined
- Rides high and close to the body for maximum comfort and concealability
- Fits up to 1.75" (45mm) belt width
- Available in full grain leather, Plain Tan finish



NEW

4585

PREVADER™

- Reinforced open-top design stays open for efficient one-handed reholstering
- Pinch® Retention Device (PRD™) enhances firearm retention by gripping the pistol's trigger guard
- Durable trilaminate construction with ballistic weave exterior, closed-cell foam center and nylon pack cloth lining for a smooth draw
- Dual snap belt loop for easy on/off access fits up to 1.75" (45mm) belt widths
- Available in Black



101

FOLDAWAY™

- Minimalist design fits many different gun models
- Design catches and holds trigger guard to help keep weapon secure and stable
- Can be folded away flat onto the belt when not in use for inconspicuous appearance
- Keeps as close to the body as possible without being an IWB holster
- Fits 1.5" (38mm) belt widths
- Available in full grain leather, Plain Tan or Plain Black finish



Concealment Holsters

BELT SLIDE



75

VENOM™

- Slim profile and compact design in a full-sized holster
- Rear belt slot pulls holster close to body for excellent concealability
- Contour-molded for exact gun fit
- Fits up to 1.75" (45mm) belt width
- Available in full grain leather, Plain Tan or Plain Black finish



77

PIRANHA™

- Unique, low-cut front provides user with a swift draw stroke
- 15° strongside cant
- Three-slot design allows custom adjustment for user preference; features both strongside and cross draw carry
- Fits up to 1.75" (45mm) belt width
- Available in full grain leather, Plain Tan or Plain Black finish



5

BLACK WIDOW™

- Features ultra hi-ride carry and thumb snap closure
- Compact profile for excellent concealability
- Dual belt slots for superior stability
- Fits up to 1.75" (45mm) belt width
- Available in full grain leather, Plain Tan or Plain Black finish

Auto Retention



PATENTED

82

CARRYLOK™

- Provides the speed of an open-top holster with the security of Auto Retention™, which retains gun upon holstering
- FingerLok™ retention mechanism secures pistol by the trigger guard upon inserting the firearm in the holster, depress lever to draw
- Features stay-open design for efficient one-handed holstering
- 16° butt forward carry
- Fits up to 1.75" (45mm) belt widths
- Available in full grain leather, Plain Tan or Plain Black finish



FINGERLOK™ RETENTION

The FingerLok™ device provides Auto Retention™ when the weapon is holstered, and is released by sweeping the device with the middle finger when drawing.

Concealment Holsters

INSIDE WAIST



100
PROFESSIONAL™

- Deep concealment design with high back to comfortably shield torso against gun's rough edges
- Features a non-slip suede-lined exterior next to body
- Rides at optimum angle inside waistband to ensure proper firing grip
- Heavy-duty spring-steel belt clip securely anchors holster to belt or trousers
- Fits up to 1.75" (45mm) belts
- Available in full grain leather, Plain Tan or Plain Black finish



3S
PISTOL POCKET®

- Inside the waistband with dual snap attachment to belt
- Fully adjustable swivel offers various carry options
- Thumb break design for those who prefer more security in an IWB holster
- Open muzzle design
- Can be worn both strongside and cross draw
- 1.75" (45mm) belt loop
- Available in full grain leather, Plain Tan finish



6D
ATB™ WAISTBAND

- Inside the waistband design provides comfort and concealability
- Thumb break design for those who prefer more security in an IWB holster
- Adjust-A-Break™ thumb break provides adjustability for a variety of gun models
- Ultra-thin and lightweight suede design for concealability
- Hi-ride; strongside or cross draw
- Heavy-duty 1.75" (45mm) clip keeps holster securely in place
- Available in Russet Suede finish



6
WAISTBAND

- Worn inside the waistband
- Ultra-thin profile provides optimum concealment
- Hi-ride; strongside or cross draw
- Heavy-duty spring-steel clip fits up to 1.75" (45mm) belts
- Available in Russet Suede or Black Leather, Plain finish



6T
WAISTBAND TUCKABLE

- Worn inside the waistband
- Ultra-thin profile provides optimum concealment
- J-Hook attachment provides strong belt retention on holster while minimizing its visibility
- Fits up to 1.5" (38mm) belt widths
- Available in Russet Suede or Black Leather, Plain finish

Concealment Holsters

ANKLE / POCKET



152

POCKET PIECE™

- Full grain leather interior for a smooth draw
- Vertical Assist finger pad for facilitating draw from pocket
- Designed with dual "pocket hooks" to prevent holster movement when drawing
- Model-specific design for better fit
- Leather is rough side out to cling to pocket interior
- Available in full grain leather



4025

INSIDE THE POCKET HOLSTER

- Extra-thin, soft holster for in pocket concealment
- Molded design keeps holster open allowing for easier draw and re-holstering into the pocket
- Unique three-layer laminate has a moisture proof membrane to keep perspiration from penetrating holster and collecting on weapon



150

NEGOTIATOR™ ANKLE HOLSTER

- Neoprene leg strap expands to fit comfortably around leg
- Lined with genuine sheepskin for comfort and breathability
- 2" adjustable elastic leg strap secures and keeps holster in place
- Holster is canted for ease of draw
- Available in full grain leather, Plain Black finish
- Model 150L comes with leg strap (pictured)

Concealment Holsters

SHOULDER

X16

AGENT™

- Crafted from premium full grain cowhide, hand-boned for a precise fit
- Featherweight, slimline design for all day comfort and concealability
- Comes with a choice of either contour-molded magazine pouch or a low-profile speedloader panel, and X-style pivoting harness that is flexible, strong and contours to the torso
- Includes two suede leather tie-downs to secure holster and offside pouch to belt
- Offered for both revolvers and semiautos
- Available in full grain leather, Plain Tan finish



The X16 harness has a pivoting design that moves with the body and adjusts to fit male and female torsos up to 48" (122cm)



AGENT™ ACCESSORIES

X16A

DOUBLE MAGAZINE POUCH



X16T

TIE-DOWN ACCESSORY



X16P

OFFSIDE ACCESSORY PANEL



X16R

SPEEDLOADER PANEL



The X15 harness adjusts to fit male and female torsos up to an optional 52" (128cm)

X15

#X15® SHOULDER HOLSTER

- Dual spring closure provides firearm retention and stability
- Half lined with full grain leather for a smooth draw
- Detachable retainer strap
- Fully adjustable soft leather harness that adjusts to a 48" chest
- Available in full grain leather, Plain Tan finish

Belts & Pouches

ACCESSORIES

Bianchi GUNLEATHER® pouches and belts are made from premium grade vegetable tanned cowhide and hand-rubbed to a rich, lustrous finish. Available in Plain Tan and Plain Black unless otherwise specified.

**B28/B29****PROFESSIONAL™ BELT 1.25" (32MM) & 1.5" (38MM)**

- Premium full grain leather, oil tanned to a rich, lustrous finish
- Solid brass buckle on tan; chrome plated brass on black belt

**B4****RANGER BELT 1.75" (45MM)**

- Popular Western billet design
- Solid brass buckle
- Full grain leather, Plain Tan or Basket Tan finish

**B9****FANCY STITCHED BELT 1.75" (45MM)**

- Natural oil tan finish reverses to suede
- Reversible, with fancy stitch design
- Solid brass buckle
- Full grain leather, Plain Tan finish

**B12****SPORT STITCHED BELT 1.5" (38MM)**

- Natural oil tan finish reverses to suede
- Reversible, with fancy stitch design
- Solid brass buckle
- Full grain leather, Plain Tan or Plain Black finish

**B21****CONTOUR BELT 1.75" (45MM)**

- Fancy stitch design
- Solid brass buckle
- Two thicknesses of heavy full grain leather
- Contoured to wrap smoothly around waist
- Full grain leather, Plain Tan finish

**20A****OPEN TOP MAGAZINE POUCH**

- Heavy-duty, spring-steel clip
- Fits belts up to 1.75" (45mm)

**21****OPEN TOP IWB MAGAZINE POUCH**

- Dual belt loop straps secure pouch to belt
- Can be angled for right or left hand carry
- Fits up to 1.75" (45mm) belts

**4065****IWB MAGAZINE POUCH**

- Extra thin, soft ballistic weave fabric, for comfortable, deep concealed carry
- Rustproof steel clip to keep magazine pouch in place
- Fits belts up to 1.75" (45mm)

**45****MAG/CUFF PADDLE**

- Paddle adjustable for carry height and angle
- Provides easy one-handed draw for handcuffs
- Fits standard, oversized and hinged handcuffs

**580****SPEED STRIPS™**

- The original compact strip loading device developed by John Bianchi more than 50 years ago
- Injection-molded from a flexible urethane material, they hold six rounds and load two at a time
- Speed Strips™ fit in most single mag/knife pouches and trouser or shirt pockets
- A perfect slim backup for speedloaders
- Available for .38/.357 and .44/.45 caliber

**4452****RANGE PORTFOLIO™**

- Comfortably carries one or two firearms in its dual, thickly padded sleeves
- Roomy interior pocket for cleaning accessories, etc., and elastic web loops for magazines or other equipment
- Features outside carry strap for hearing protectors



Built for durability and comfort, Bianchi offers a collection of sporting holsters and accessories designed to meet your needs. Bianchi's sporting line has something for everyone whether for hunting, range or field use.



1L LAWMAN™

- Western style, front strap closure; fits single-action revolvers
- Hi-ride carry, open muzzle-design
- Full suede lining
- Foldover belt loop fits 1.75" (45mm) to 2.25" (58mm) belts
- Available in full grain leather, Plain Tan finish



111 CYCLONE™

- Thumb snap closure for secure fit and covered trigger guard design for both hunting and concealment applications
- Unique belt loop design allows either strongside or cross draw carry
- Quick release thumb snap
- Hi-ride carry, open muzzle design for both semiautos and revolvers
- Fully suede lined with a 1.75" (45mm) belt slot
- Available in full grain leather, Plain Tan finish



5BHL THUMBSNAP

- Features integral thumb snap closure
- Strongside hi-ride carry; carries gun close to body for added comfort
- Fully suede lined
- 2" - w3" holsters fit 1.75" (45mm) belt slots
- 4" and larger holsters include 1.75" (45mm) and 2.25" (58mm) belt slots; revolvers only
- Available in full grain leather, Plain Tan finish



19L THUMBSNAP

- Wide belt loop provides stable carry close to the body; hi-ride for maximum comfort and concealability
- Integral thumb snap enhances handgun retention
- Fully suede lined
- 1.75" (45mm) belt loop; semiautos only
- Available in full grain leather, Plain Tan finish



7000 ACCUMOLD® SPORTING HOLSTER

- Ideal for field, hunting and concealment carry
- Contour-molded, high-density trilaminated AccuMold® construction for an exacting fit
- Hi-ride carry with closed muzzle and 10° forward cant that aids in both comfort and presentation
- Unique Coptex™ poly-knit lining for a smooth draw
- Sleek front strap closure incorporates Adjust-A-Strap™ feature to ensure a secure fit over the hammer
- 1.75" (45mm) injection-molded belt slot
- Available in Black Ballistic Weave finish



7001 ACCUMOLD® THUMBSNAP

- Suitable for both outdoor and concealment use, this holster rides at a 10 to 13° cant for a fast, instinctive draw
- Thumb snap design incorporates the Bianchi® Adjust-A-Strap™ feature to ensure a secure fit over the hammer
- Contour-molded, high-density trilaminated AccuMold® construction for an exacting fit
- Coptex™ 100% polyknit lining for a smooth draw
- 1.75" (45mm) injection-molded belt slot
- Available in Black Ballistic Weave finish



7201 TRAINING BELT 1.75" (45MM)

- Four-part laminate for long-lasting shape and exceptional durability
- Hook and loop closure for quick on/off ease
- Firm polyethylene center strip sandwiched between a high-density foam, with a ballistic weave outer and a durable nylon lining



PHOTO COURTESY DOD



MILITARY PRODUCT COLOR OFFERINGS

Model	Finish	Model	Finish
UM84I	Black, OD	M13	Black, OD
UM84II	Black, OD	M1020	Black, OD
UM84III	Black, OD	M1025	Black, OD
UM84R	Black, OD	M1030	Black, OD
UM92I	Black, OD	M1415	Black, OD
UM92II	Black, OD	M1425	Black
UM84H	Black, OD	M1430	Black, OD
M12	OD		

**UM84
UNIVERSAL MILITARY
HOLSTER**

- Commercial offering of the military standard issue M12 holster
- System can be worn 14 different ways
- Removable flap for conversion to thumb break
- Ambidextrous
- Equipped with Quick-Lock™ belt fastener
- Includes field cleaning rod
- Available for revolvers and semi-autos
- Fits up to 2.25" (58mm) belt



**UM92I/UM92II
UNIVERSAL MILITARY HOLSTER**

- Commercial offering of the military standard issue M12 holster with the addition of a polymer trigger guard insert that stabilizes the trigger guard of certain large frame autos; ideal for Sig Sauer and Glock weapons
- Ambidextrous
- Includes field cleaning rod
- Equipped with Quick-Lock™ belt fastener
- Two sizes to fit 4" - 5" semi-autos
- Compatible with all UM84 accessories
- Fits up to 2.25" (58mm) belt



**T6505
TAC HOLSTER**

- Quick-Lock™ clip for attachment to T6510 Accessory Panel, to any MOLLE attachment system or on an equipment belt up to 2.25" (58mm) wide
- Features polymer trigger guard shield that protects and stabilizes
- Rugged Ranger™ trilaminate construction
- Ambidextrous
- Available in Black Ballistic Weave finish



**M12
UNIVERSAL MILITARY HOLSTER**

- U.S. Armed Forces standard issue for the Beretta M9 sidearm
- Removable flap for conversion to thumb break
- Ambidextrous
- System can be worn 14 different ways
- Converts to shoulder holster with M13 or UM84H
- Equipped with Quick-Lock™ belt fastener
- Includes field cleaning rod



**T6500
TAC HOLSTER LT**

- Adjustable to fit most pistols with tactical lights mounted
- Quick-Lock™ belt clip for attachment to T6510 Accessory Panel, to any MOLLE attachment system or to an equipment belt up to 2.25" (58mm) wide
- Secondary retainer strap for a double lock on the thumb break for additional retention when required
- Rugged Ranger™ trilaminate construction
- Available in Black Ballistic Weave finish

Military Holsters

CONCEALABLE ARMOR | TACTICAL ARMOR | COMMUNICATIONS | DUTY GEAR/HOLSTERS | PROTECTIVE GEAR | ACCESSORIES | FIREARMS | LESS LETHAL | PERFORMANCE APPAREL | SURVIVABILITY SYSTEMS | FORENSICS | ARMOR SYSTEMS | TRAINING ACADEMY



HOLSTER NOT INCLUDED

M1430
UNIVERSAL MILITARY ADAPTER

- Adapter kit allows Safariland® MLS 15 Locking Fork or QLS 19 to attach to the back of the UM84/UM92 Universal Military Holsters
- Locking Fork allows the holster to be mounted directly into MOLLE loops
- Allows quick switching of holster from leg to vest or any other mounting point when using QLS



M1425
TACTICAL HIP EXTENDER

- Provides a rigid platform and upper attachment point for accessories
- Includes a high-mounted leg strap
- Features Quick-Lock™ belt fastener
- Available in Black, Universal Digital Camo
- Fits up to 2.25" (58mm) belt



M1030

M1025
MILITARY MAGAZINE POUCH

- Holds two magazines
- Trim & compact
- Quick-Lock™ belt fastener attaches securely to web belt
- Fits up to 2.25" (58mm) belt



M1020
WEB PISTOL BELT

- Tough mil-spec nylon construction
- Official military plastic buckle
- One size fits 30" - 48" (76cm-122cm) lengths and 2.25" (58mm) width



M1415
THUMB SNAP SYSTEM

- For use when flap is removed from UM92/UM84/M12
- Offers faster performance in tactical situations
- Provides added retention



M13
CHEST HARNESS

- Cross-chest design is ideal for helicopter and other close-quarter use
- Ambidextrous design
- Completely adjustable
- Dual positioning



T6510
MODULAR ACCESSORY PANEL

- Five attachment points to mount accessories (two are bi-directional)
- Adjustable ambidextrous leg strap with 2" quick-release buckle for quick deployment
- Hook and loop vertical adjustment to custom-tailored panel location on thigh
- Non-slip Gription™ mesh backing keeps panel securely in place on leg
- Web attachment points for use with Bianchi® military holster with Quick-Lock™ belt fastener



T6521
DOUBLE AR15 POUCH

- Holds two 30-round mil-spec (or other similar width) AR15 type magazines
- Dual hook/loop and snap closure for added security
- Quick-Lock™ belt clip for secure attachment
- Rugged ballistic trilaminate construction
- Available in Black Ballistic Weave finish



Revisit the handcrafted glory of the Old West with our line of cowboy gear and enjoy the quality of our world-famous genuine leather holsters and belts. We use only premium grade, full grain, vegetable tanned cowhide – the highest quality, most expensive leather. Developed and used by the world-class shooters of Team Bianchi, this is authentic cowboy gear that was designed to perform both in and out of the arena. Above all, it carries the legendary name Bianchi® and is designed and produced in America. See our website for more information on these rigs.

KENDA LENSEIGNE SIGNATURE SERIES RIGS FEATURE:

- A hidden tension adjustment to provide a customized smooth draw during mounted shooting and a weight lifter style elongated back for support
- Corrosion-resistant steel reinforced holster and welt area is double stitched with heavy nylon thread for added strength
- Strongside holster provides 10° cant, cross draw 20°
- Full grain leather lining in holster and belt for better grip while riding and performing in matches
- Two-piece 2" wide belt available in either straight or 1.5" drop design

SMOKECHASER™

- Full grain floral embossed cowhide with snake pattern lambskin insert; available in Black or Cognac, floral finish
- Visit website to view additional finishes



GETAWAY™

- Premium grade, full grain cowhide; Chestnut Tan or Black, plain finish



PATH BLAZER™

- Premium grade full grain cowhide with basketweave insert; available in Chestnut Tan or Black, plain finish



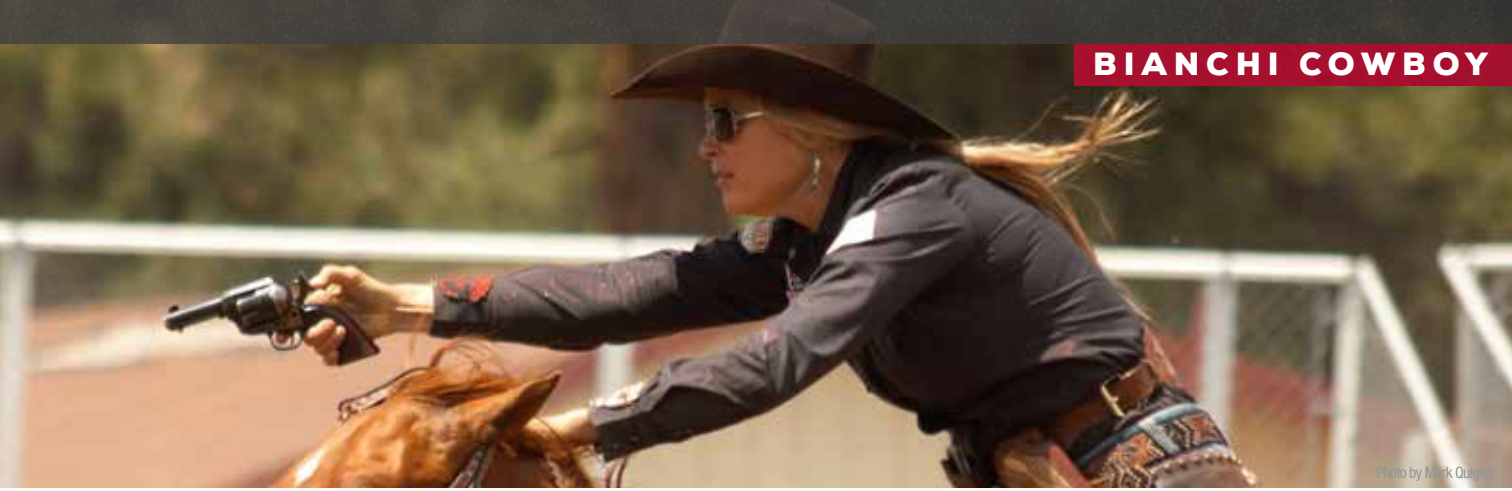

Photo by Mark Quigg



The Kenda Lenseigne Signature Series by Bianchi® Cowboy was developed by Kenda Lenseigne, first ever female Overall World and National Champion and holder of 13 world records, along with the Bianchi Cowboy Shooting Team, encompasses every design aspect required for record breaking mounted shooting performance.

KENDA LENSEIGNE
SIGNATURE SERIES



CATTLE DRIVER™

- Premium grade full grain cowhide; Chestnut Tan with tan/white cowhide inserts or Plain Black with black/white cow hair inserts
- Visit website to view additional finishes



**LIMITED EDITION
KENDA LENSEIGNE
SERIES RIGS**

- Special color and finish combination offered
- Visit safariiland.com/bianchi-cowboy for product details



**LONG GUN
HOLDER**

- Designed to fit 16" lever action rifles and shotguns
- Saddle mount
- Available in premium full grain leather, Chestnut Tan or Plain Matte Black finish



LONG GUN SCABBARD

- Designed to fit 16" rifles and carbines
- Closed muzzle with drain hole
- Includes three tie-downs to secure scabbard, two horizontal and one vertical
- Adjustable ride height strap for snug carry on saddle horn
- Solid brass buckles on tan models, chrome covered brass buckles on black
- Available in premium full grain leather, Chestnut Tan or Plain Matte Black finish
- Shotgun Holder also available, visit safariiland.com/bianchicowboy for product details

Bianchi Cowboy



CLEARWATER™

- Holster and belt feature a smooth, full grain leather lining for a quicker draw and sturdiness on the hip
- Multi-angle belt loop for customized strong side and cross draw carry
- Belt loop adjusts 35° forward and rearward for cant customization and personalized draw
- Belt is 2.25" (58mm) wide with tapered ends; choose cartridge loops for .38 or .45 Long Colt
- Select a second Clearwater holster (shown) for cross draw or use as dual strongside holster
- Premium grade full grain cowhide; available in Chestnut Tan or Plain Black finish



HONDITO™ BELT

- Designed for mounted shooting and at proper width for use with Kenda Lenseigne holsters
- Adjustable for cross draw carry
- Belt is fancy stitched and padded for comfort, and is 2" (50.8mm) wide with tapered ends
- Premium grade full grain cowhide; available in Chestnut Tan or Plain Black finish



HONDO™

- Designed for mounted shooting
- Suede lining in holster and belt for better grip while riding
- Adjustable for cross draw carry
- Belt is fancy stitched and padded for comfort, and is 2.25" (58mm) wide with tapered ends
- Belt loop adjusts 35° forward and rearward for cant customization and personalized draw
- Premium grade full grain cowhide; available in Chestnut Tan or Plain Black finish



WILD CLEARWATER™

- Smooth, full grain leather lining for a quick draw
- Specifically designed for Colt 1911 style pistols
- Full-length Sight Channel™ and adjustable for cross draw carry
- Belt loop adjusts 35° forward and rearward for cant customization and personalized draw
- Flared top for faster, instinctive re-holstering
- Available in Chestnut Tan with white stitching or Plain Black with black stitching



WILD CLEARWATER™ DUAL MAGAZINE POUCH

- Double stitched welt with heavy nylon thread for extra strength
- Specifically designed for use with two 1911-style magazines
- Available in Chestnut Tan or Plain Black



TEXAS OUTLAW™

- Classic drop loop-style cowboy rig with suede lined belt and steel lined holster
- Smooth leather lined for a rapid draw
- Reinforced with rawhide to hold the holster open with a flared top for faster, instinctive re-holstering
- Belt is 3" (76mm) wide with billet ends; choose cartridge loops for .38 or .45 Long Colt
- Cross draw holster is available as an optional second holster; order Texas Outlaw™ CD Holster
- Premium grade full grain cowhide; available in Chestnut Tan or Plain Black finish



CALIFORNIA OUTLAW™

- Smooth, full grain leather lining in holster for a quicker draw
- Suede lined belt is 2.25" (58mm) wide with billet ends; choose cartridge loops for .38 or .45 Long Colt
- Cross draw holster (shown) sold separately
- Premium grade full grain cowhide; available in Chestnut Tan or Plain Black finish

P R O T E



CTIVE GEAR



The Hatch® brand is known as one of the finest in protective performance gloves for law enforcement, tactical, military, medical and industrial safety markets. Only the finest leathers, along with synthetic and high-tech materials, are used to ensure the protective gear performs to the world's most uncompromising standards.



FIVE POINTS OF INNOVATION - TASK SERIES

ALL MODELS IN THE HATCH TASK SPECIFIC LINE FEATURE THESE FIVE INNOVATIVE FEATURES



TOUCHSCREEN-COMPATIBLE KNUCKLE FOR USE WITH ELECTRONICS

The knuckle pad provides the ability to quickly swipe the phone to take or send a call without having to remove gloves or worry about contaminating the device.



HATCH SIGNATURE ERGO-CUT™ THUMB PATTERN FOR AN ACCURATE AND COMFORTABLE FIT

Conforms to the natural curvature of the hand and offers greater dexterity and freedom of movement than a “single palm pattern.” Because we have opposable thumbs, a single piece palm bunches up and twists on the thumb when the hands are clasped.



ARTICULATED STRAP

Accommodates a larger watch as it is angled away from the wrist.



ALL-SOFT CUFF TO FLEX AROUND A WRISTWATCH

Many gloves are primarily made with a “rigid cuff,” which is actually a detriment to a watch wearer in that the cuff then has to be pushed over or under the watch. With a soft compression cuff, the cuff gently compresses around the watch during wrist flexion, and allows the watch to be usable without having to constantly adjust the cuff.



HATCH PATENTED CUT-RING

This feature allows for the optional removal of the index finger for trigger control, without unraveling the remaining edge.

ADVANCED TOUCHSCREEN SYSTEM

FOCUS ON FUNCTIONALITY

Hatch offers a full line of gloves designed specifically for use with touchscreen devices. Each glove is designed with purpose and intention based on the job at hand. Our Touchscreen gloves feature embedded ATS™ technology in the index knuckle allowing an officer to access a touchscreen device without worry of contaminating their device during grimy situations.



Duty Gloves

TASK SERIES

See more gloves in the Task Specific Series line in the Tactical and Traffic sections.



PATENTED

TSK324

TASK MEDIUM

- Durable synthetic palm with touchscreen capabilities in all fingers
- Soft and lightweight, breathable stretch material on back of hand
- Hatch touchscreen technology
- Reinforced fingertips
- Sizes: S-2XL



PATENTED

TSK323

TASK LIGHT LEATHER

- Genuine goatskin leather palm
- Soft and lightweight, breathable stretch material on back of hand
- Touchscreen feature on middle finger knuckle
- Great for fine motor skill requirements
- Sizes: S-2XL



PATENTED

TSK325

TASK MEDIUM CUT-RESISTANT

- Palm liner made with Kevlar® fiber
- Durable synthetic palm with touchscreen technology in all fingers
- Soft, lightweight and breathable stretch material on back of hand
- Reinforced fingertips
- Sizes: S-2XL



PATENTED

TSK326

TASK HEAVY KNUCKLE

- Patented Z-pattern palm with diamond grip for heavy-duty applications
- Shock absorbing TPR (Thermoplastic Rubber) knuckle
- Durable synthetic palm material with touchscreen technology in index finger
- Soft, lightweight and breathable stretch material on back of hand
- Reinforced fingertips
- Sizes: S-2XL

DUTY GLOVES

Duty Gloves

NS430**SPECIALIST® ALL-WEATHER
NEOPRENE SHOOTING/DUTY**

- Constructed of neoprene for comfort, flexibility and warmth
- Palm made of Synsi-feel™ synthetic leather for excellent grip and accurate feel
- Extreme-Grip™ sewn onto palm and fingertips for maximum grip
- Hook and loop closure
- Sizes XS-2XL

**SG20P****DURA-THIN™ POLICE SEARCH DUTY**

- Unlined and constructed from soft, durable premium leather that is cut "second-skin" thin for superior feel and dexterity while shooting, searching, handcuffing or driving
- Short elasticized cuff provides a snug fit and will not interfere with jacket or shirt cuff
- Sizes S-2XL





DUTY GLOVES



CT250
COOLTAC™ POLICE DUTY CE

- Lightweight glove design offers excellent comfort in warm climates
- 3-D knit spacer performance fabric on back
- Palm is constructed of ultra-thin leather for dexterity
- Extreme-Grip™ provides weapon control and reinforcement of wear area
- Features the Hatch® Signature Ergo-Cut™ for excellent fit
- Hook and loop closure
- Sizes S-2XL

CYCLING GLOVES



HLG250
SHEARSTOP™ HALF-FINGER CYCLE CE

- Same features as the FLG250
- Sewn-in loops for easy removal
- Sizes S-2XL



Duty Gloves

WINTER DUTY GLOVES



WPG100

WINTER PATROL

- Made of leather and a water-resistant shell
- Digitized print in the palm increases surface area to allow for a better grip
- C70 Thinsulate™ insulation with a soft brushed tricot inner liner
- Leather cinch strap provides a snug fit to block out cold
- Sizes S-2XL



NS430L

WINTER SPECIALIST® ALL-WEATHER NEOPRENE SHOOTING/DUTY

- Palm made of Synsi-feel™ synthetic leather provides excellent grip and accurate feel
- Extreme-Grip™ sewn onto the palm and fingertips (except the index finger) to facilitate trigger control
- Dual inner lining of 3M Thinsulate™ insulation and breathable, waterproof Hipora® work together to keep the hand warm and dry
- Hook and loop closure
- Sizes S-2XL

CUT-RESISTANT



PPG2

ARMORTIP™ PUNCTURE PROTECTIVE GLOVE

- Synthetic suede leather palm
- Exclusive ArmorTip® system offers optimum protection on the leading edges of the fingertips and thumb
- Neoprene and spandex back with hook and loop closure
- Sizes XS-3XL

Duty Gloves

CUT-RESISTANT



SGK100

STREET GUARD™



- Design offers excellent protection from cuts and sharp objects over the entire hand
- Digitized synthetic leather palm with Extreme-Grip™ non-slip cradle, offering a sure grip and positive weapon control
- Palm and fingers lined with Kevlar® fiber
- Neoprene and spandex back provides maximum comfort while providing a proper, snug fit
- Hook and loop closure
- Sizes XS-3XL



RFK300

RESISTER™



- Constructed of goatskin leather and Kevlar® fabric
- Knit liner provides moderate cut resistance
- Short elasticized cuff
- Sizes XS-3XL



Honeywell SPECTRA

FM2000

FRISKMASTER™

- Honeywell Spectra® knit liner protects from sharp objects
- Constructed of premium leather
- Wrist length elasticized cuff
- Sizes XS-3XL



SGX11

STREET GUARD™



- Dyneema® liner for the ultimate in cut protection, comfort and dexterity for the entire hand
- Digitized synthetic leather palm with Extreme-Grip™ nonslip cradle, offering sure grip and positive weapon control
- Neoprene and spandex back allows air circulation for maximum comfort while providing a proper, snug fit
- Hook and loop closure
- Sizes XS-3XL

Tactical Gloves



KSG500
SHOOTING GLOVES 

- Lightweight, comfortable shooting gloves designed for use in SWAT and tactical operations
- Kevlar® brand fiber interlock fabric construction
- Form-fitting design and thin, yet durable leather palm provides excellent tactility, dexterity and grip for high-performance shooting
- Short, open cuff allows easy pull on and removal
- Sizes S-2XL



HMG100
HATCH® MECHANIC'S

- Synthetic suede leather palm with high-density foam padded reinforcements
- Abrasion-resistant heel pad
- Flexible, breathable spandex back with ergonomically split high-density foam padding
- Reinforced fingertips with Toughtek™ grip patches
- Double-layered reinforced cradle
- Elasticized wrist with hook and loop closure
- Sizes S-2XL



BNG190
FLIGHT GLOVES

- Nomex® IIIA blend construction
- Durable, yet soft premium leather palm
- Engineered to U.S. military specifications
- Sewn entirely with Nomex® thread
- Sizes S-2XL



PATENTED

SOG-600
OPERATOR™ TACTICAL

- Leather palm sewn with all Nomex® thread
- Nomex® / Kevlar® brand fiber blend construction
- Elasticized wrist keeps the Operator taut, while the elasticized gauntlet keeps out foreign objects and prevents snagging
- Patented Cut-Ring stitching allows optional removal of the index finger for trigger control without unraveling the remaining edge
- Sizes S-2XL



LR25
REACTOR™

- Designed for rappelling, tactical entry and shooting. It is also excellent for disturbance control operations
- Thick foam padding on the back is ergonomically split to improve dexterity
- Tested leather construction makes the gloves extremely strong and durable
- An additional layer of leather in the palm provides added durability during rapid rappels, and unpadded index finger allows maximum trigger control
- Hook and loop closure
- Sizes S-2XL

Tactical Gloves



PATENTED

TSK327**TASK HEAVY SOGL**

- Nomex® fiber and goatskin leather construction
- Hinged EVA foam knuckle for shock absorption and maximum dexterity
- Z-pattern palm reinforcement with EVA foam shock absorption
- Sizes: S-2XL



PATENTED

TSK328C**TASK HEAVY SOGL LT**

- Soft and lightweight, breathable stretch material on back of hand
- Hinged EVA foam knuckle for shock absorption and maximum dexterity
- Z-pattern palm reinforcement with EVA foam shock absorption
- Sizes: S-2XL



PATENTED

TSK329**TASK HEAVY SOGHK**

- Nomex® fiber and goatskin leather construction
- Hinged hard knuckle for shock absorption and maximum dexterity
- Z-pattern palm reinforcement with EVA foam shock absorption
- Sizes: S-2XL

**TSK330C****TASK HEAVY SOGHK LT**

- Soft and lightweight, breathable stretch material on back of hand
- Hinged EVA foam knuckle for shock absorption and maximum dexterity
- Z-pattern palm reinforcement with EVA foam shock absorption
- Sizes: S-2XL

RIOT CONTROL GLOVES

PATENTED

SP100**DEFENDER™ II WITH STEEL SHOT** 

- Double layered leather palm, spandex back and Ergo-Cut™ design
- Foam padded fingers with 4 oz. of steel shot in each knuckle area
- Spandex fabric allows for freedom of movement
- Hook and loop closure
- Sizes S-2XL

Not available for sale in some states. Check local city and state laws pertaining to SAP Gloves.



WG1000S

WHITE COTTON PARADE CE

- For special occasions and formal events in either law enforcement or military engagements, as well as for directing traffic or crowds
- Constructed of 100% medium-weight cotton
- Snap cuff design
- Sizes S-XL



DNR100

DAYNITE™ REFLECTIVE CE

- Constructed of black spandex with patches of a retro-reflective microprism material with cube-corner prisms, three times more efficient at reflecting light than glass bead systems
- Allows the wearer to be seen by motorists at the critical viewing distances of 100 to 600 feet
- The stretchable spandex fabric allows the DayNite™ glove to be worn alone or over virtually any other glove
- Hold palm outward to reveal the red STOP signal, and use the yellow-green markers on outside of hand to direct traffic onward
- Sizes S/M, L/XL



TSK331

TASK HI VIZ

- Durable synthetic Hi Viz suede with reflective striping on palm
- Hatch® touchscreen technology on knuckle
- Perfect for low-light, traffic management and high visibility requirements
- Available in Yellow and Orange
- Sizes: S-2XL



Knee & Elbow Pads



PATENTED

XTAK100/200/300/400/500/600

XTAK™ KNEE PADS

- Extremely light and flexible with superior protection and shock absorption with the flexibility to move the way your body moves
- Unique X-shaped thermal plastic urethane (TPU) shell
- EVA high-density foam for superior shock absorption
- Lightweight TPU and Cordura® nylon construction
- Forceful spring-back action that gives you the protection you need
- COOLMAX® inner surface for wicking moisture away
- Anti-slip inner surface to keep pad secured
- Elastic adjustable straps with Hatch® Rapid Deployment Clips and hook and loop closure for secure fit
- One size fits all



KP250

CENTURION™ KNEE PADS

- 1/2", dual-density foam covered in durable Cordura® nylon
- Polyurethane thermoplastic nonslip caps fastened with color-keyed grommets provide additional shock absorption and ensure long-lasting wear
- Dual hook and loop fastened 1.5" wide (3.8cm) elastic straps with reinforced bar tacking provide a comfortable and secure fit for all sizes
- Hatch® Rapid Deployment Clips for quick on and off
- One size fits all



PATENTED

XTAK150/250/350/450/550/650

XTAK™ ELBOW PADS

- Elbow pads with similar features as the XTAK™ knee pads
- Dual elastic straps with hook and loop fasteners
- One size fits all



**S7****SLING PACK**

- Convenient carry bag for everything from magazines to cell phones
- Constructed of heavy-duty 1000-denier nylon
- Three exterior compartments, eight interior pockets and one hidden padded compartment on side closest to body
- MOLLE loops cover the front of the bag for easy attachment of accessories
- One key clip, two pen/pencil pockets; multiple magazine/clip holders
- Unique clip on back for easy on/easy off access and minimizes bouncing while running
- Heavy-duty hardware for durability
- Weight: 2 lbs. (32 oz.), 0.9 kg.

**A6****MUNITIONS BAG**

- Designed to organize a 37/40mm launcher and plenty of munitions
- Features two clear vinyl document pockets (one interior, one exterior) and several large exterior zipper pouches for additional gear
- Constructed of durable nylon and heavy-duty hardware with two molded rubber carry handles
- 2" wide padded nylon shoulder straps allow the A6 to be carried as a backpack and stowed away when not in use
- Durable 600-denier polyester and 420-denier nylon inside with PVC reinforcement construction
- Exterior dimensions: 38"L x 18.5"W x 4"H (96.52cm x 46.99cm x 10.16cm)



E4**EXOTECH® CARRY BAG**

- Designed to carry and store the ExoTech® riot suit
- Constructed of Cordura® nylon
- Nylon web carry handles are on both sides and ends
- Features a separate helmet section
- Padded shoulder strap

**M2****MISSION SPECIFIC GEAR BAG**

- Designed to carry riot or SWAT gear and includes a separate helmet storage area
- Water-resistant Cordura® nylon
- Heavy-duty zippers and removable nylon web shoulder strap
- Removable rigid bottom in the main compartment and padded exterior walls in the helmet compartment
- Three zippered cargo pockets and two zippered mesh pockets on the exterior hold a wide variety of items
- Nylon web carry handles are on both the sides and ends
- Hook and loop straps on the padded top can secure a baton or flashlight
- Exterior dimensions: 34"L x 13"W x 12"H (86.4cm x 33cm x 30.5cm)

**G3****GIANT SWAT BAG**

- Construction consists of water-resistant polyester shell with PVC backing and heavy-duty reinforced handles and straps
- Nylon web carry handles are on both the sides and ends
- The G3 may be worn as a backpack using the 2"-wide (5cm) padded adjustable straps affixed to the bottom
- The exterior features two zippered mesh end pockets and a total of five clear vinyl map/document pockets on the top and sides
- The interior has four expandable zippered mesh pockets, four zippered pockets and one zippered pouch with padded walls for fragile gear
- Exterior dimensions: 41.5"L x 14"W x 12"H (105.4cm x 35.56cm x 30.48cm)



FIREARMS



ACCESSORIES



For decades these three legacy brands have made up the most honored names in the firearms accessories marketplace with products ranging from premium cleaning accessories and maintenance equipment to chemicals and gun accessories. KleenBore®, Break Free® and Rogers™ have been proud suppliers of products for our military, law enforcement, and hunting and shooting enthusiasts.

Cleaning Kits



UK213 Kit

CLASSIC CLEANING KITS

- These Classic kits feature the best made cleaning components in the industry
- Securely packaged in a rugged, reusable polypropylene storage carrying case
- Rods in the Handgun, Rifle and Muzzleloading Kits are made of a smooth, high-grade steel with a black oxide finish and rotating handles
- Plastic muzzle guard protects the crown of the barrel
- Shotgun kits feature a polished aluminum, three-sectioned rod set
- 2 oz. Break Free® CLP® to clean, lubricate and protect the firearm
- Double-ended nylon utility gun brush
- 100% cotton patches



POCKIT HANDGUN KIT

- Unique design of the PocKit handgun kit packs a two-section steel cleaning rod and accessories into a storage handle
- Holds a phosphor brush, cotton mop and brass jag for easy, convenient storage and carrying
- First rod section with muzzle guard, cleans up to 5" barrels
- Second rod section extends the length up to 8 3/8"
- Rod sections accept all KleenBore® handgun accessories (#8-32 thread style)
- PocKit cleaning sets are offered in a variety of popular handgun calibers

POC220	.22
POC222	.38/.357/9mm
POC224	.40/.41/10mm
POC226	.44/.45

CLASSIC HANDGUN KITS

Part #	Caliber/Gauge
K211	.22
PK210	.38/.357/9mm
K220	.40/.41/10mm
K212	.44/.45

CLASSIC RIFLE KITS

K205	.22/.223/5.56mm
K204	.243/.25/6.5mm
K206	.264/.270/7mm
K207	.30/7.62mm
K209	.41/.45

CLASSIC SHOTGUN KITS

SH0216	12
SH0217	20

CLASSIC SMALL BORE KITS

K17	.17
-----	-----

CLASSIC UNIVERSAL KITS

UK213	All Handguns/Rifles/Shotguns
SAF300	All Handguns/Rifles/Shotguns

*See kit contents in chart below

CLASSIC KIT CONTENTS

	STEEL ROD WITH SWIVEL HANDLE		ALUMINUM ROD		SHOTGUN ACCESSORY ADAPTER	ACCESSORY ADAPTER	NYLON BRISTLE GUN BRUSH	PHOSPHOR BRONZE BORE BRUSH	COTTON BORE MOP	SLOTTED PATCH HOLDER	BRASS CLEANING JAG	BREAK FREE® CLP®	COTTON CLEANING PATCHES	MUZZLE GUARDS
	SECTIONS	LENGTH"	SECTIONS	LENGTH"										
UNIVERSAL	4	30			•	•	•	•	•	2		•	•	•
RIFLE	4	30				•	•	•	•	•		•	•	•
HANDGUN	1	10				•	•	•	•	•		•	•	•
SHOTGUN			3	32			•	•	•	•		•	•	•
MUZZLELOADING	5	37			•	•	•			2		•	•	•
SMALL BORE	3	34					•	•	•		•	•	•	



POLICE KITS

- Tailored specifically to meet the cleaning needs of firearms that are used heavily in the field
- The police handgun kits and the shotgun kit include a 1/4" diameter, precision ground stainless steel rod
- The 5.56mm, 7.62mm and .30-06 kits include a solid steel, black oxide rod
- Both rods feature a muzzle guard to prevent damage to the bore and a rotating handle that provides a precise clean by allowing the rod to tightly follow the rifling
- Each kit features a 2 oz. bottle of Break Free® CLP® solution
- Includes ½ oz. Break Free® Lubricant/Protectant – a synthetic oil specially formulated for modern firearms
- Kits also include 100% cotton patches, a doubled-ended nylon brush, a Silicone Gun and Reel cloth and caliber specific jags, brushes and mops

PS50	.38/.357/9mm	PS53	5.56mm
PS51	.40/.41/10mm	PS54	7.62mm
PS52	.44/.45	PS55	.30-06

FIELD PACK KITS

- These compact, easy to carry, go anywhere kits are favorites of hunters, law enforcement and the military
- Everything needed for a complete cleaning is included in the rugged nylon pouch with a belt keeper or modular webbing attachments, hook and loop closures and compartments for rods and accessories
- In the field or on the range, these kits are compact enough to carry for fast and easy removal of impacted mud, snow or a squib load



POU302B

Part #	Color	Caliber/Gauge
POU301B	Black	All Caliber - Handgun/Rifle
POU302B	Black	AR-15/M16 .223/5.56mm
POU302T	Tan	AR-15/M16 .223/5.56mm

CONCEALABLE ARMOR | TACTICAL ARMOR | COMMUNICATIONS | DUTY GEAR/HOLSTERS | PROTECTIVE GEAR | **FIREARMS ACCESSORIES** | LESS LETHAL | PERFORMANCE APPAREL | SURVIVABILITY SYSTEMS | FORENSICS | ARMOR SYSTEMS | TRAINING ACADEMY

Cleaning Rods

CLASSIC ONE-PIECE RODS

- A variety of non-segmented rods in steel and aluminum in an array of lengths
- All rods are carefully crafted to be strong, no-fray and remain straight in the barrel, won't bow, break, bend or fray, which can cause damage to precious rifling

Part#	Caliber/Gauge	Length	Material	Accessories
OP105	.17 Cal./Airgun	33"	Steel	Brush, Mop, Brass Jag
OP106	.22-.45 Handgun	6 1/2"	Steel	Slotted Patch Holder
OP107	.22-.45 Rifle	33"	Steel	Slotted Patch Holder
OP108	Shotgun All Gauges	34"	Aluminum	Slotted Patch Holder Accessory Adapter



Classic One-Piece Steel Rod



Classic One-Piece Aluminum Shotgun Rod

MULTI-SECTIONAL CLEANING RODS

- KleanBore® rods are precision-machined to exacting tolerances and surface smoothness
- Won't bow, break, bend or fray, which can cause damage to precious rifling
- Durable nylon handles on the rifle and pistol models rotate smoothly, allowing brushes and jags to travel efficiently down the bore
- All multi-section rods are packaged in well-made vinyl pouches for long-term storage



Part#	Caliber/Gauge	Sections	Length	Material	Accessories
A171	Shotgun All Gauges	3	32"	Aluminum	Slotted Patch Holder, Shotgun Accessory Adapter
S170	.22-.45 Handgun/Rifle	4	30"	Steel	Slotted Patch Holder, Accessory Adapter
SB169	.17 Small Bore	3	34"	Steel	Phosphor Bronze Brush, Cotton Bore Mop, Jag

SAF-T-CLAD® CLEANING RODS

- Saf-T-Clad® products are the result of a technological breakthrough involving epoxy thermal setting resins
- Resins are carefully applied in the United States on local, high-grade, solid-steel rods, and securely bond our Saf-T-Clad coating
- This special process provides an unbelievably smooth surface for the ultimate in rifling and bore protection
- An excellent choice for shooters who do a lot of cleaning and expect absolute precision and protection for their equipment

Part#	Description	Caliber	Length	Sections
SAF303	Small Bore Rod	.17/.204	33"	1
SAF302	Handgun Rod	.22-.45	8"	1
SAF400	One-Piece Rifle Rod	.22-.45	33"	1



SAF-T-Clad® Deluxe One Piece Rifle and Handgun Rods



SAF-T-Clad® .17 Caliber One Piece Rifle Rod



**SAF301
UNIVERSAL ROD SET**

- Compact, reusable clamshell case contains a four-piece sectional rod with black nylon muzzle guard for up to 30" of length
- Handgun/rifle patch holder, shotgun patch holder and accessory adapter (.22-.45, all gauges)

ROD ADAPTERS

These carefully crafted accessories guarantee perfect, smooth mating to rods, preventing peeling or mismatched segments that can seriously damage bores



ACC11



ACC16



ACC17

SLOTTED PATCH HOLDERS

Part#	Description	Use/Caliber/Gauge
ACC11	Brass Handgun/Rifle	.22-.45
ACC16	Nylon Shotgun	All Gauges

ACCESSORY/CONVERSION ADAPTERS

ACC17	Aluminum Accessory Adapter	Accepts all KleenBore® shotgun accessories (5/16-27)
-------	----------------------------	--



PHOSPHOR BRONZE BRUSHES

- These precisely designed brushes feature KleenBore® carefully-made, thicker, straight bronze wire bristles
- Designed with rounded, smoother bristle tips rather than sharp, crimped, narrow imported brushes
- These bronze brushes offer more safe and effective cleaning power
- Will not easily bend from force down the bore
- Will not damage precious rifling

Rifle Bore Brushes

- A175 .17/.200 Caliber
- A177 .22/.223/5.56mm
- A178 .243/.25/6mm/6.5mm
- A179 .270/7mm
- A180 .30/7.62mm
- A163 .338/8mm
- A181 .35/9mm
- A160 .375/.380 Caliber
- A182 .44/.45 Caliber
- A194 .50 Caliber

Handgun Bore Brushes

- A188 .22 Caliber
- A189 .32 Caliber
- A190 .38/.357/9mm
- A191 .40/.41/10mm
- A192 .44/.45
- A193 .50 Caliber

Shotgun Bore Brushes

- A183 .410-Gauge
- A184 20-Gauge
- A186 12-Gauge



UT221

NYLON BRISTLE GUN BRUSH

- This military-style brush is great for cleaning any type of firearm, especially where a gentle touch is required. Nylon bristles are rugged and solvent-resistant



UT222

STAINLESS STEEL GUN BRUSH

- Rugged stainless steel bristles make short work of caked-on powder residue and burn marks on revolver top straps, frames and cylinders



UT223

PHOSPHOR BRONZE GUN BRUSH

- A superb, general purpose, gentle-on-the-finish brush for cleaning powder and lubrication residue from handguns, rifles and shotguns

Cotton Patches & Cloths

GUN CLEANING PATCHES

- Premium quality 100% cotton flannel provides maximum absorbency and bore protection
- Precision cut to ensure the proper fit and maximum cleaning performance when used in conjunction with our cleaning jags or patch holders
- These same quality 100% cotton patches are available bulk-packaged for high volume users such as competition shooters, gun clubs, law enforcement agencies, gunsmiths, and others

Part#	Size	Caliber/Gauge	Quantity
P200	7/8"	Small Bore	100 count
P201	1 1/4"	.22-.270 Caliber	100 count
P202	1 3/4"	.28-.35 Caliber	75 count
P203	2 1/4"	.38-.45/.410 - 20-Gauge	50 count
P204	3"	12/16-Gauge	25 count
CP16B	1 1/4"	.22-.270 Caliber	500 count
CP17B	1 3/4"	.28-.35 Caliber	500 count
CP13B	2 1/4"	.38-.45/.410 - 20-Gauge	250 count
CP18B	2 1/4"	.38-.45/.410 - 20-Gauge	500 count
CP14B	3"	12/16-Gauge	250 count
CP19B	3"	12/16-Gauge	500 count
CP21B	1 1/4"	.22-.270 Caliber	1000 count



GC220S

SILICONE GUN & REEL CLOTH

- Restore and protect the luster of a firearm with our top-quality silicone injected cotton flannel
- Returns a brilliant sheen to firearms surface
- Removes handling marks, fingerprint oil, and provides a layer of rust protection
- 100 square inch cloth

GC221

LEAD AWAY® CLEANING CLOTH

- This chemically treated cloth is ideal for removing tough lead and carbon build-up
- Excellent for removing burn rings on cylinders and on stainless steel
- 110 square inch cloth

Caution: Excessive rubbing may remove bluing



CHAMBER FLAG

- On the range and when transporting or storing semi-automatic handguns, a chamber flag immediately indicates that the gun is clear and no round can be chambered
- Comes with two per pack

CF9	.45/9mm
CF22	.22 Caliber



BL304 BORE INSPECTOR®

- Fiber optics light the bores of handguns, rifles and shotguns to make checking for leading, fouling, and rust fast and easy
- Ideal for regular firearms maintenance or for examining used guns prior to purchase
- Two AAA replaceable batteries supplied

Cleaners/Lubricants/Preservatives

Made in the
USA



CLEANER LUBRICANT PRESERVATIVE (CLP®)

- Originally developed for the U.S. Military and proven in the world's most extreme conditions
- Break Free® CLP® is the gold standard formula for the ONE STEP lubricating and protectant firearm solution
- More than a superior lubricant, CLP actually cleans firing residue and other contaminants from the bore, moving parts and exterior of firearms while simultaneously reducing friction and protecting from corrosion

Part#	Description	Accessory
CLP-2	4 oz. Aerosol Spray	Extender Tube
CLP-3	1/2 oz. Squeeze Bottle	Dropper Tip
CLP-4	4 oz. Squeeze Bottle	Extender Tube
CLP-5	1 Pint Bottle	Trigger Spray
CLP-7	1 Gallon Jug	—
CLP-8	1 Liter Bottle	Trigger Spray
CLP-11	2 oz. Bottle	Pump Spray
CLP-12	12 oz. Aerosol Spray	Extender Tube
CLP-16	.68 oz. Squeeze Bottle	—
CLP-20	2 oz. Bottle	Child-resistant cap
CLP-PS	7.5ml Tube	Needle Applicator



DP-2 COLLECTOR® KIT

- **4 oz. CLP®:** Cleans, lubricates and preserves using the highest quality synthetic oils and special friction reducing, anti-wear additives and rust inhibitors
- **4 oz. Collector:** Developed to protect firearms for up to five years in storage. Will not degrade under heat or pressure and resists damage caused by fingerprint residue

CONCEALABLE ARMOR | TACTICAL ARMOR | COMMUNICATIONS | DUTY GEAR/HOLSTERS | PROTECTIVE GEAR | FIREARMS ACCESSORIES | LESS LETHAL | PERFORMANCE APPAREL | SURVIVABILITY SYSTEMS | FORENSICS | ARMOR SYSTEMS | TRAINING ACADEMY



Made in the
USA



LUBRICANT PRESERVATIVE

(LP)

- Originally developed for fully automatic cannons used by the U.S. military, Break Free® has taken this technology designed to keep weapons working under sustained fire and brought it to the consumer market
- Contains specially formulated polymerized synthetic oils for improved boundary film strength, plus multiple ingredients to reduce friction, stop build-up of foreign particles and inhibit rust and corrosion
- Safe for all gunmetal and gunmetal finishes from blued steel to titanium, as well as polymer composite firearms. Also prevents galling on stainless steel
- Non-solvent formula minimizes drain off when firearm is holstered

LP-3	.5 oz. squeeze bottle with dropper tip
LP-4	4 oz. squeeze bottle with extender tube
LP-5	1 pint bottle with trigger sprayer
LP-PS	7.5 ml tube with needle applicator

LP-PS

LP-5

LP-4

CLEANER & SOLVENT



CO-4 COLLECTOR® (4 OZ.)

Developed to protect firearms for up to five years in storage, Collector® exceeds stringent military specifications. Recommended for the occasional hunter or sports shooter, as well as knife and sword collectors. It's ideal for seasonal sports equipment before placing in storage. In one test, Collector protected steel panels from rust and corrosion for over 1200 hours in 100% humidity.

- Does not degrade to waxy residue under heat or pressure
- Resists damage from fingerprint residue and minimizes the need for frequent wipe down
- Perfect for gun collectors, armories and museums



GC-16 POWDER BLAST™ (12 OZ.)

- Powder Blast™ keeps all guns clean and dry by blasting away firing residues. Use it on trigger groups and mechanisms to quickly and easily remove contaminants, without leaving a white residue or unpleasant odor
- Eliminates powder residue, plastic streaking, grease and oil build-up
- No disassembly required – the extender tube provides easy access to hard-to-reach areas
- Will not hydrolyze to form hydrochloric acid, unlike products containing 1,1,1 Trichloroethane
- After using Powder Blast, protect firearms with Break Free® CLP®, or Collector® products



Rogers Accessories

CONCEALABLE ARMOR | TACTICAL ARMOR | COMMUNICATIONS | DUTY GEAR/HOLSTERS | PROTECTIVE GEAR | FIREARMS ACCESSORIES | LESS LETHAL | PERFORMANCE APPAREL | SURVIVABILITY SYSTEMS | FORENSICS | ARMOR SYSTEMS | TRAINING ACADEMY



PATENTED

64339

ULTIMATE BORE SQUEEG-E™ CLEANING KIT

- Patented Squeeg-e provides advanced cleaning without the use of patches
- Complete system includes everything needed to clean all firearms from a .22 pistol to a 12-Gauge shotgun

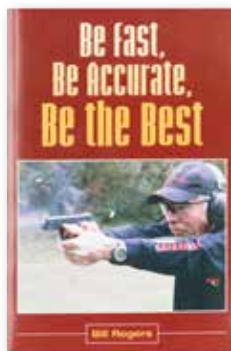

66502

BE FAST, BE ACCURATE, BE THE BEST – BOOK

Bill shares his life experiences to bring the readers into the world of Reactive Shooting. He then takes them through a step by step program to make them safer and more competent gun handlers, as well as giving them the skills to survive a real life battle.

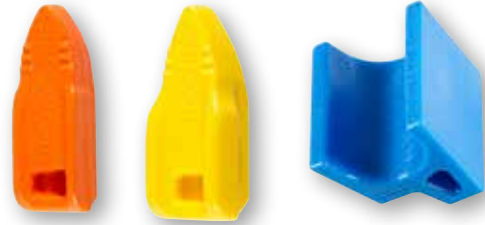

64394

TAP RACK TRAINING AID

- Most efficient way to practice dry fire drills
- Place in the magazine to prevent slide stop from engaging
- Slide passes over training aid so device does not need to be re-loaded into the magazine for continual training
- Can be used improperly seated in magazine for malfunction drills
- Available in 3, 20 and 100-packs in Orange, Yellow and Blue

64394	9mm & 40 cal.
64395	45 ACP
64396	5.56

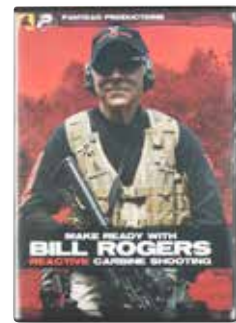
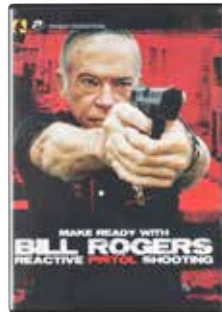

66500/66501

MAKE READY WITH BILL ROGERS – DVDs

- Reactive Pistol Shooting – Bill Rogers walks you through Rogers Shooting School steps to teach reactive pistol shooting and how to accurately draw and knock down plates in .5 seconds
- Reactive Carbine Shooting – Successfully engage and hit small reactive targets that are moving and only exposed for a fraction of a second



LESS LETHAL



DEFENSE TECHNOLOGY®



The Defense Technology® brand offers a complete range of the industry's most trusted less lethal products. Manufactured to exacting specifications and quality standards, the products have led the industry for decades. From duty aerosols and less lethal impact munitions to our Distraction Device® products, chemical munitions and more, Defense Technology products are the choice of law enforcement, corrections and military personnel around the world.

THE FINEST TRAINING AIDS FOR THE FINEST PRODUCTS

First Defense® is the world's most widely used pepper spray in law enforcement and corrections. In recognizing the diverse environments and challenges our public safety professionals face each day, our comprehensive First Defense line utilizes a color code system to identify the intensity of that product.

The First Defense family of OC aerosol sprays are EDW safe.

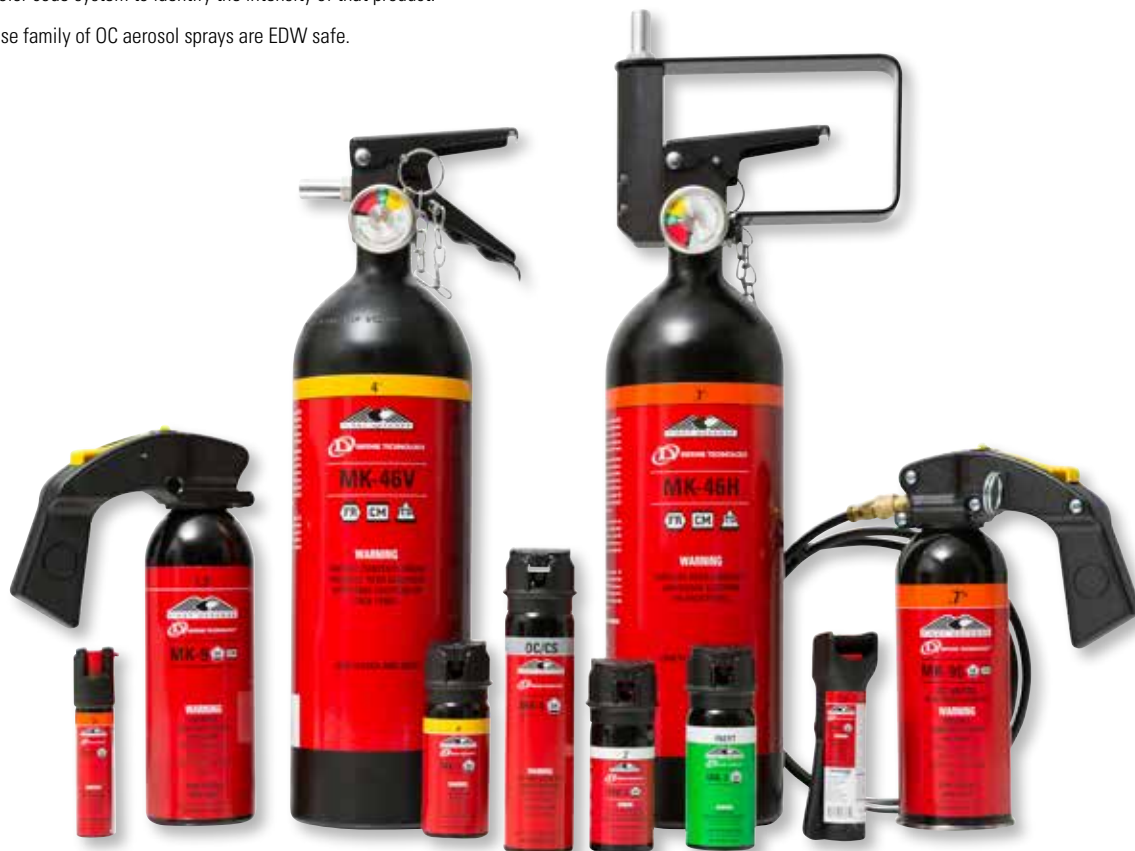

.2% White Band

- 56125 MK-2 Stream
- 5039 MK-3 Stream
- 5036 MK-3 Foam
- 5439 MK-3 Stream/360°
- 5049 MK-4 Stream
- 5046 MK-4 Foam
- 5449 MK-4 Stream/360°
- 5069 MK-6 Stream
- 56185 MK-8 Stream
- 5099 MK-9 Stream
- 5746 MK-46V Stream
- 5846L MK-46H Stream
- 5546 MK-46R Stream

.4% Yellow Band

- 56325 MK-2 Stream
- 56324 MK-2 Cone
- 5239 MK-3 Stream
- 5239A MK-3 Stream/360°
- 56334 MK-3 Cone
- 56332 MK-3 Foam
- 5249 MK-4 Stream
- 5249A MK-4 Stream/360°
- 56344 MK-4 Cone
- 56342 MK-4 Foam
- 5269 MK-6 Stream
- 5299 MK-9 Stream
- 56392 MK-9 Foam
- 56346V MK-46V Stream
- 56346H MK-46H Stream
- 56346R MK-46R Stream

.7% Orange Band

- 56725 MK-2 Stream
- 3005 MK-3 Stream
- 56733 MK-3 Stream/360°
- 3035 MK-3 Cone
- 4005 MK-4 Stream
- 56343 MK-4 Stream/360°
- 4035 MK-4 Cone
- 6005 MK-6 Stream
- 56764 MK-6 Cone
- 56785 MK-8 Stream
- 56784 MK-8 Cone
- 56795 MK-9 Stream
- 9005 MK-9 Fogger
- 43896 MK-9S Vapor
- 43890 MK-9S Vapor w/ Wand Adapter
- 56746V MK-46V Stream
- 56746H MK-46H Stream
- 56746R MK-46R Stream

CS Grey Band

- 56931 MK-3 Gel
- 56231 MK-3 Gel/360°
- 56941 MK-4 Gel
- 56241 MK-4 Gel/360°
- 56991 MK-9 Gel
- 56291 MK-9 Gel/360°

1.3% Red Band

- 56825 MK-2 Stream
- 56824 MK-2 Cone
- 56822 MK-2 Foam
- 43345 MK-3 Stream
- 56833 MK-3 Stream/360°
- 43344 MK-3 Cone
- 56842 MK-3 Foam
- 56831 MK-3 Gel
- 56531 MK-3 Gel/360°
- 43445 MK-4 Stream
- 56843 MK-4 Stream/360°
- 43444 MK-4 Cone
- 56832 MK-4 Foam
- 56841 MK-4 Gel
- 56541 MK-4 Gel/360°
- 43665 MK-6 Stream
- 56864 MK-6 Cone
- 56884 MK-8 Cone
- 56895 MK-9 Stream
- 43953 MK-9 Fogger
- 43950 MK-9 Fogger w/ Wand Adapter
- 56792 MK-9 Foam
- 56891 MK-9 Gel
- 56591 MK-9 Gel/360°
- 43046 MK-46V Stream
- 56846H MK-46H Stream
- 43046R MK-46R Stream

OC/CS Grey Band *Non-EDW Safe

- 56025 MK-2 Stream*
- 56035 MK-3 Stream*
- 56045 MK-4 Stream*
- 56095 MK-9 Stream*
- 56046V MK-46V Stream*
- 56046H MK-46H Stream*
- 56046R MK-46R Stream*

Inert *Non-EDW Safe

- 5129 MK-2 Stream
- 5125 MK-2 Cone*
- 5126 MK-2 Foam
- 5139 MK-3 Stream
- 5439I MK-3 Stream/360°
- 5139F MK-3 Cone*
- 5136 MK-3 Foam
- 56431 MK-3 Gel
- 56631 MK-3 Gel/360°
- 5149 MK-4 Stream
- 5449I MK-4 Stream/360°
- 5149F MK-4 Cone*
- 5146 MK-4 Foam
- 56441 MK-4 Gel
- 56641 MK-4 Gel/360°
- 5169 MK-6 Stream
- 5189 MK-8 Stream
- 5199 MK-9 Stream
- 5199F MK-9 Fogger*
- 5196 MK-9 Foam
- 56491 MK-9 Gel
- 56691 MK-9 Gel/360°
- 49950 MK-9 Fogger w/ Wand Adapter*
- 5546I MK-46R Stream



CHOOSING YOUR PEPPER SPRAY IS EASY, JUST ANSWER THESE THREE QUESTIONS AND USE THE CHART BELOW:

- 1 WHAT INTENSITY DO YOU NEED?
- 2 HOW DO YOU WANT TO DELIVER THE OC?
- 3 HOW MUCH PRODUCT WILL YOU NEED?



STREAM AEROSOL SIZE SPECS

MK-2:	7-10 SHORT BURSTS	10-12 FT.
MK-3:	10-12 SHORT BURSTS	10-12 FT.
MK-4:	20-25 SHORT BURSTS	10-12 FT.
MK-6:	12-14 SHORT BURSTS	10-12 FT.
MK-8:	5-7 SHORT BURSTS	10-12 FT.
MK-9:	14 SHORT BURSTS	18-20 FT.
MK-46:	26 SHORT BURSTS	25-30 FT.

	MK-2	MK-3	MK-4	MK-6	MK-8	MK-9	MK-46V	MK-46H
.2%								
.4%								
.7%								
1.3%								
OC/CS								
INERT								

CHART KEY

STREAM	CONE	FOAM	360°
DUTY AEROSOL	CROWD MANAGEMENT	INDOOR/OUTDOOR	

Less Lethal Impact Munitions



PATENTED



BIP BLUNT IMPACT PROJECTILE 40MM DIRECT FIRE MUNITIONS WITH PAYLOAD OPTIONS

- Projectile incorporates unique Collapsible Gel Head design
- Accurate to 131 feet / 40 meters
- Payload options deliver irritant or marking payloads in addition to blunt trauma
- Passed human effects assessments for safety and effectiveness

OC CS MARKING INERT



PATENTED



DIRECT IMPACT® ADJUSTABLE RANGE 40MM DIRECT FIRE MUNITIONS WITH PAYLOAD OPTIONS

- Projectile design has unique user-adjustable gas-bleed feature
- Allows velocity and kinetic energy to be adjusted for two design points, addressing close-in and extended range engagements
- Standard range velocity allows for engagements of 1.5 – 40 meters
- Extended range velocity allows for engagements of 40 – 70 meters
- Crushing nose dampens blunt trauma while delivering payload

OC CS MARKING INERT



DIRECT IMPACT® STANDARD RANGE 40MM DIRECT FIRE MUNITIONS WITH PAYLOAD OPTIONS

- Accurate to 131 feet / 40 meters
- Crushing nose dampens blunt trauma while delivering payload
- Passed extensive human effects assessments for blunt impact and penetration

OC CS MARKING INERT



DIRECT IMPACT® LE EXTENDED RANGE 40MM DIRECT FIRE MUNITIONS WITH PAYLOAD OPTIONS

- Accurate to 230 feet / 70 meters
- Crushing nose dampens blunt trauma while delivering payload
- Passed extensive human effects assessments for blunt impact and penetration
- Do not use at distances closer than 33 feet / 10 meters

OC CS MARKING INERT



PATENTED



DIRECT IMPACT® RELOADABLE TRAINING KITS 40MM RELOADABLE TRAINING ROUND

- Provides the same point of impact accuracy as the 40mm munitions it simulates
- The most cost-effective way to conduct training
- Reloading the munitions takes seconds and one hex key
- For use on inanimate targets
- Available in 50-Shot or 250-Shot Kits
- Available in Standard Range or LE Extended Range

40mm BIP Collapsible Gel Rounds

6425	BIP Collapsible Gel Round
6420	BIP Collapsible Gel Round, OC
6422	BIP Collapsible Gel Round, CS
6423	BIP 40mm Collapsible Gel Round, Inert Powder
6426-ML	BIP Collapsible Gel Round, Marking Liquid
6426-MP	BIP Collapsible Gel Round, Marking Powder

Direct Impact Adjustable Range

6320-A	Direct Impact OC
6322-A	Direct Impact CS
6323-A	Direct Impact Inert
6326-A	Direct Impact Marking

Direct Impact Standard Range

6320	Direct Impact OC
6322	Direct Impact CS
6323	Direct Impact Inert
6326	Direct Impact Marking

Direct Impact Extended Range

6320LE	Direct Impact OC
6322LE	Direct Impact CS
6323LE	Direct Impact Inert
6326LE	Direct Impact Marking

Reloadable Training Kits

6530-50	Direct/Exact Impact 50-Shot Kit
6530	Direct/Exact Impact 250-Shot Kit
6530LE-50	Extended Range Direct/Exact Impact 50-Shot Kit
6530LE	Extended Range Direct/Exact Impact 250-Shot Kit



Less Lethal Impact Munitions



PATENTED



EXACT iMPACT™ ADJUSTABLE RANGE 40MM DIRECT FIRE MUNITIONS

- Projectile design has unique user-adjustable gas-bleed feature
- Allows velocity and kinetic energy to be adjusted for two design points, addressing close-in and extended range engagements
- Standard range velocity allows for engagements of 1.5 – 40 meters
- Extended range velocity allows for engagements of 40 – 70 meters



EXACT iMPACT™ STANDARD RANGE 40MM DIRECT FIRE MUNITIONS

- Most accurate direct fire munitions
- Accurate to 131 feet / 40 meters
- Produced under exclusive license from U.S. Army
- Passed extensive human effects assessments for blunt impact and penetration



EXACT iMPACT™ LE EXTENDED RANGE 40MM DIRECT FIRE MUNITIONS

- Most accurate direct fire munitions
- Accurate to 230 feet / 70 meters
- Passed extensive human effects assessments for blunt impact and penetration
- Do not use at distances closer than 33 feet / 10 meters



EXACT iMPACT™ 24-SHOT RELOADABLE TRAINING KIT 40MM RELOADABLE TRAINING ROUND

- Foam nose bodies are reusable
- Pre-loaded bases are fast to make ready and disposable afterwards
- The training munitions deliver similar accuracy as the live munitions

eXact iMPact Adjustable Range

6325-A eXact iMPact

eXact iMPact Standard Range

6325 eXact iMPact

eXact iMPact Extended Range

6325LE eXact iMPact

Reloadable Training Kits

6525 eXact iMPact 24-Shot Kit

6530-50 Direct/Exact Impact 50-Shot Kit

6530 Direct/eXact iMPact 250-Shot Kit

6530LE-50 Extended Range Direct/Exact Impact 50-Shot Kit

6530LE Extended Range Direct/Exact Impact 250-Shot Kit



Less Lethal Impact Munitions

37MM ROUNDS 37/40MM ROUNDS 40MM ROUNDS

- Comprehensive offering of area and direct fire munitions
- Available in 37mm, 37/40mm or 40mm munitions
- Widely used by corrections and law enforcement agencies for crowd control or single subject compliance

AREA CONTROL MUNITIONS



STINGER® 32 CAL. RUBBER BALLS

STINGER® 60 CAL. RUBBER BALLS

40mm Rounds

- 6096 Stinger 32 Cal. Rubber Balls
- 6097 Stinger 60 Cal. Rubber Balls
- 6098 Multiple Wood Baton
- 6064 Multiple Rubber Baton
- 6099 Multiple Foam Baton
- 6025 Bean Bag

37/40mm Rounds

- 6296 Stinger 32 Cal. Rubber Balls
- 6297 Stinger 60 Cal. Rubber Balls
- 6298 Multiple Wood Baton
- 6299 Multiple Foam Baton
- 6225 Bean Bag

37mm Rounds

- 1196 Stinger 32 Cal. Rubber Balls (5.5")
- 1197 Stinger 32 Cal. Rubber Balls
- 1198 Stinger 60 Cal. Rubber Balls (5.5")
- 1199 Stinger 60 Cal. Rubber Balls
- 1176 Multiple Wood Baton
- 1177 Multiple Rubber Baton
- 1178 Multiple Foam Baton
- 1225 Bean Bag

DIRECT FIRE MUNITIONS



MULTIPLE WOOD BATON

MULTIPLE FOAM BATON

MULTIPLE RUBBER BATON

BEAN BAG



12-GAUGE

Stinger 32 Cal. Rubber Balls

- 3016 Standard Velocity
- 3020 High Velocity

Stinger 68 Cal. Rubber Balls

- 3071 Single Rubber Ball
- 3071-2 Double Rubber Ball
- 3071-3 Triple Rubber Ball

Drag Stabilized™

- 3027 Bean Bag Round
- 3028 Marking Bean Bag Round

Fin Stabilized

- 3021 Fin Stabilized Round

12-GAUGE ROUNDS

- Comprehensive offering of area and direct fire munitions
- Widely used by corrections and law enforcement agencies for single subject compliance

AREA CONTROL MUNITIONS

DIRECT FIRE MUNITIONS



STINGER® 32 CAL. RUBBER BALLS

DRAG STABILIZED™ ROUND

FIN STABILIZED ROUND

STINGER® 68 CAL. SINGLE, DOUBLE OR TRIPLE RUBBER BALL



AERIAL WARNING/SIGNALING MUNITIONS WITH PAYLOAD

40MM 50/100/200/300 METERS

- Designed to travel the indicated distance and deflagrate 20 ft. above the target when launcher is held at a 15° elevation angle
- Delivers a sound and light output which are noticeable in day or night conditions
- Produces 170 dB of sound output at 5 ft
- Produces 5 million candelas for 7.5 milliseconds
- Tactile feature on the nose of the cone to indicate designated distance



AERIAL WARNING/SIGNALING MUNITIONS

40MM 50/100/200/300 METERS

- Designed to travel the indicated distance and deflagrate 20 ft. above the target when launcher is held at a 15° elevation angle
- Delivers a sound and light output which are noticeable in day or night conditions
- Produces 170 dB of sound output at 5 ft
- Produces 5 million candelas for 7.5 milliseconds
- Tactile feature on the nose of the cone to indicate designated distance



AERIAL WARNING/SIGNALING MUNITIONS

12-GAUGE 50/100 METERS

- Designed to travel the indicated distance and deflagrate 20 ft. above the target when shotgun is held at a 5° elevation angle
- Delivers a sound and light output which are noticeable in day or night conditions
- Produces 170 dB of sound output at 5 ft
- Produces 2.2 million candelas for 7.5 milliseconds

40mm Aerial Warning/Signaling Munitions w/Payload

60280C	50 meters
60290C	100 meters
60300C	200 meters
60310C	300 meters

6028CN	50 meters
6029CN	100 meters
6030CN	200 meters
6031CN	300 meters

6028CS	50 meters
6029CS	100 meters
6030CS	200 meters
6031CS	300 meters

6028IM	50 meters
6029IM	100 meters
6030IM	200 meters
6031IM	300 meters

40mm Aerial Warning/Signaling Munitions

6028WS	50 meters
6029WS	100 meters
6030WS	200 meters
6031WS	300 meters

12-Gauge Aerial Warning/Signaling Munitions

3031	50 meters
3029	100 meters

Pyrotechnic Chemical Grenades

Defense Technology® offers a large assortment of chemical grenades providing options for most any tactical situation. These high-volume pyrotechnic grenades utilize a standard M201A1 type fuze and deliver large plumes of smoke and/or agent.



FLAMELESS TRI-CHAMBER

- The design of this grenade allows the contents to burn within an internal can and disperse the agent safely with reduced risk of fire
- Designed primarily for tactical situations to detect and/or dislodge a barricaded subject
- It is not recommended to launch this grenade

OC CN CS SMOKE



HAN-BALL™

- Fast burning pyrotechnic grenade with a rubber ball exterior
- Delivers a high volume of agent in 15 seconds

OC CN CS SMOKE



TRIPLE-CHASER®

- Grenade separates into three sub-munitions to cover greater area and payload coverage
- Sub-munitions land approximately 20 ft. apart with an approximate burn time of 20-30 seconds

OC CN CS SMOKE



SPEDE-HEAT™

- Long-burning, continuous discharge grenade delivers a high-volume of smoke and agent
- Burn time approximately 30-40 seconds

OC CN CS



WHITE & COLORED SMOKE

- Smoke is discharged for approximately 30-40 seconds
- Ideal for signaling, communication, distraction and crowd control
- Smoke Colors: White, Black, Blue, Green, Red or Yellow
- Maximum HC Smoke Grenades are also available in Large- and Military-Style canisters

SMOKE



RIOT CONTROL

- Same long-burning, continuous discharge capabilities as the Spede-Heat™ grenade in a smaller canister
- Delivers a high-volume of smoke and agent
- Burn time approximately 30-40 seconds

OC CN CS



POCKET TACTICAL

- Though this device is slightly over 4" in length, it produces a smoke cloud so fast it appears to be an enveloping screen produced by a full size tactical grenade
- Burn time 20-40 seconds
- Smoke Colors: White, Blue, Green, Red or Yellow

OC CN CS SMOKE

Flameless Tri-Chamber

1030	OC	PATENTED
1031	CN	
1032	CS	
1033	Saf-Smoke™	

Han-Ball™

1099	OC	PATENTED
1091	CN	
1092	CS	
1093	Saf-Smoke™	

Triple-Chaser®

1020	OC	PATENTED
1025	CN	
1026	CS	
1027	Saf-Smoke™	

Spede-Heat™

1070	OC	PATENTED
1071	CN	
1072	CS	

Riot Control

1080	OC	PATENTED
1081	CN	
1082	CS	

White & Colored Smoke

1062	Black Smoke	
1063	Saf-Smoke™	
1064	Blue Smoke	
1065	Green Smoke	
1067	Red Smoke	
1069	Yellow Smoke	
1073	Large-Style Max HC Smoke	
1083	Military-Style Max HC Smoke	

Pocket Tactical

1019	OC	PATENTED
1015	CN	
1016	CS	
1017	Saf-Smoke™	
1017B	Saf-Smoke™ Blue	
1067G	Saf-Smoke™ Green	
1017R	Saf-Smoke™ Red	
1017Y	Saf-Smoke™ Yellow	



Defense Technology® non-pyrotechnic chemical grenades provide heavy concentrations of payload that immediately contaminate the area and are non-flammable and safe for indoor usage.



AEROSOL OC VAPOR

- Delivers a very high concentration of agent in a powerful mist and requires very minimal decontamination
- Removing the subject from the affected area to fresh air resolves respiratory effects within minutes

OC INERT



INSTANTANEOUS BLAST

- Upon initiation of the detonator there is enough force to split at six machined grooves on the outside surface of the canister expelling the powder payload
- Well suited for affecting numerous subjects grouped within a contained area, using wind to the advantage

OC CN CS INERT



FLAMELESS EXPULSION

- This compact grenade features a CO² cartridge which utilizes the released pressure to expel the powder payload
- Most commonly used in tactical deployments by law enforcement or corrections and can affect a confined area of up to approximately 1,500 sq ft.

OC CN CS INERT



OC AEROSOL FOGGER

- Delivers a payload of 1.3 MC% in less than 15 seconds and is ideal for area denial in enclosed spaces such as attics or garages with minimal cleanup
- Available in 1 oz. and 6 oz. canisters

OC INERT

Aerosol OC Vapor	
1056	OC Vapor
1055	Inert Vapor
Instantaneous Blast	
1040	OC
1041	CN
1042	CS
1043	Inert / Practice
Flameless Expulsion	
2040	OC
2041	CN
2042	CS
2043	Inert / Practice
OC Aerosol Fogger	
56814	1.3% 1 oz.
56854	1.3% 6 oz.
56544I	Inert 1 oz.
56594I	Inert 6 oz.
OC/CS Aerosol	
1050	OC/CS (Not Shown)

Pyrotechnic Chemical Projectiles



SKAT SHELL®

40MM & 37MM PYROTECHNIC CHEMICAL MUNITIONS

- Delivers four or five pyrotechnic sub-munitions
- Can be launched to 100 yards
- Force multiplier for mobile field force teams
- Affects a wider area at once

OC CN CS SMOKE



SPEDE-HEAT™ SHORT RANGE

37MM PYROTECHNIC CHEMICAL MUNITIONS

- Single dual-ported short range canister will travel 75 yards
- Available with either a chemical payload or Saf-Smoke™
- Allows for an effective and rapidly developed release line regardless of your position relative to the target group

OC CN CS SMOKE



SPEDE-HEAT™ LONG RANGE

40MM & 37MM PYROTECHNIC CHEMICAL MUNITIONS

- Single dual-ported long range canister will travel 150 yards
- 37mm available with either a chemical payload, colored or Saf-Smoke™
- 40mm only available with chemical payload or Saf-Smoke
- Allows for an effective and rapidly developed release line regardless of your position relative to the target group

OC CN CS SMOKE



GROUND MARKER

40MM PYROTECHNIC CHEMICAL MUNITIONS

- Delivers pyrotechnic smoke or irritant payload downrange at 100, 200 or 300 meters
- Available with a chemical payload, Saf-Smoke™ or colored smoke
- Applications for this product include crowd direction and control, marking and obscuration

OC CN CS SMOKE

Skat Shell® 40mm

6170	OC	PATENTED
6171	CN	
6172	CS	
6173	Saf-Smoke™	

Skat Shell™ 37mm

1170	OC	PATENTED
1171	CN	
1172	CS	
1173	Saf-Smoke™	

Spede-Heat™ 37mm Short Range

2000	OC	PATENTED
2001	CN	
2002	CS	
2003	Saf-Smoke™	

Spede-Heat™ 37mm Long Range

1187	OC	PATENTED
1181	CN	
1182	CS	
1183	Saf-Smoke™	
1184	Green	
1185	Red	

Spede-Heat™ 40mm Short Range

6280	OC	PATENTED
6282	CS	
6283	Saf-Smoke™	

Spede-Heat™ 40mm Long Range

6180	OC	PATENTED
6181	CN	
6182	CS	
6183	Saf-Smoke™	

Ground Marker 100m

6480	OC	PATENTED
6482	CS	
6483	Saf-Smoke™	

Ground Marker 200m

6580	OC	PATENTED
6582	CS	
6583	Saf-Smoke™	

Ground Marker 300m

6680	OC	PATENTED
6682	CS	
6683	Saf-Smoke™	



Non-Pyrotechnic Chemical Projectiles



FERRET® BARRICADE PENETRATOR

LIQUID & POWDER

- Available in 37mm, 40mm and 12-gauge
- Frangible projectile filled with chemical agent
- Upon impacting a barrier, the nose cone ruptures and instantaneously delivers the agent payload inside a structure

OC CN CS INERT

Ferret® Liquid



37MM OR 40MM



12-GAUGE

Ferret® Powder



37MM OR 40MM



12-GAUGE



MUZZLE BLAST

12-GAUGE, 37MM, 37/40MM & 40MM

- Deploys a heavy concentration of agent directly on suspect or to area
- Immediately contaminates the area

OC CN CS INERT



12-GAUGE



37MM



40MM

Ferret® Liquid

2260	40mm OC
2261	40mm CN
2262	40mm CS
2263	40mm Inert

1160	37mm OC
1161	37mm CN
1162	37mm CS
1163	37mm Inert

3010	12-Ga OC
3011	12-Ga CN
3012	12-Ga CS
3013	12-Ga Inert

Ferret® Powder

2290	40mm OC
2291	40mm CN
2292	40mm CS
2293	40mm Inert

1190	37mm OC
1191	37mm CN
1192	37mm CS
1193	37mm Inert

3090	12-Ga OC
3091	12-Ga CN
3092	12-Ga CS
3093	12-Ga Inert

Muzzle Blast Powder

6040	40mm OC
6041	40mm CN
6042	40mm CS
6043	40mm Inert

6240	37/40mm OC
6241	37/40mm CN
6242	37/40mm CS
6243	37/40mm Inert

1140	37mm OC
1141	37mm CN
1142	37mm CS
1143	37mm Inert

3040	12-Ga OC
3041	12-Ga CN
3042	12-Ga CS
3043	12-Ga Inert



CONCEALABLE ARMOR | TACTICAL ARMOR | COMMUNICATIONS | DUTY GEAR/HOLSTERS | PROTECTIVE GEAR | ACCESSORIES | LESS LETHAL | PERFORMANCE APPAREL | SURVIVABILITY SYSTEMS | FORENSICS | ARMOR SYSTEMS | TRAINING ACADEMY

Tactical Devices



PATENTED



LOW ROLL™ 12-GRAM DISTRACTION DEVICE®

- Produces 175 dB of sound output at 5 ft.
- Produces 6-8 million candelas for 10 milliseconds
- Utilizes standard military-style M201A1 fuze
- Hex design reduces rolling when deployed
- Available in both non-reloadable and reloadable options
- Available in Humidity-resistant versions



PATENTED



LOW ROLL II™ 11-GRAM DISTRACTION DEVICE®

- Produces 175 dB of sound output at 5 ft.
- Produces 6-8 million candelas for 10 milliseconds
- Utilizes standard military-style M201A1 fuze
- Smaller profile, superior performance
- Hex design reduces rolling when deployed
- Only available in non-reloadable option
- Available in Humidity-resistant versions

Low Roll™ Distraction Device®

8902NR	Non-Reloadable Low Roll
8902NRSC	Non-Reloadable Low Roll with Safety Clip
8902NR-HH	Non-Reloadable Low Roll, High Humidity
8902NRSC-HH	Non-Reloadable Low Roll w/ SC, High Humidity
8933	Low Roll Reloadable DD Body

Low Roll II™ Distraction Device®

8922	Non-Reloadable Low Roll II
8922NRSC	Non-Reloadable Low Roll II with Safety Clip
8922-HH	Non-Reloadable Low Roll II, High Humidity
8922NRSC-HH	Non-Reloadable Low Roll II w/ SC, High Humidity

Distraction Device® Reloads

7007	4-Gram Reload
7007SC	4-Gram Reload w/SC
7007-HH	4-Gram Reload High Humidity
7007SC-HH	4-Gram Reload w/SC, High Humidity
8901	12-Gram Reload
8901SC	12-Gram Reload with Safety Clip
8901-HH	12-Gram Reload, High Humidity
8901SC-HH	12-Gram Reload w/ SC, High Humidity



DISTRACTION DEVICE® RELOADS

RELOADABLE DISTRACTION DEVICE®

Defense Technology® offers a variety of reload options for Distraction Device® munitions.

- Produces 175 dB of sound output at 5 ft.
- Produces 6-8 million candelas for 10 milliseconds
- Utilizes standard military-style M201A1 fuze
- 7001CI intended for use with WallBanger™ breaching tool
- 7007 reduced charge 4-Gram reload
- Available in humidity-resistant versions



PATENTED

DISTRACTION
DEVICE® RELOAD



PATENTED

DISTRACTION
DEVICE® RELOAD W/
SAFETY CLIP



12-GRAM COMMAND
INITIATED RELOAD



PATENTED

REDUCED CHARGE
4-GRAM RELOAD



LOW ROLL™ / LOW ROLL II™ TRAINING BODY & FUZE

- Same weight and function as the live Low Roll™ or Low Roll II™ munitions
- Color-coded military training blue
- Low cost allows for increased training opportunities on a set budget
- 8933T and 8922T bodies only accept the 1697T & 1697TSC Training Fuzes
- Non-ATF controlled item
- Delivers 120 dB of sound output at 5 ft.

Low Roll/Low Roll II Training Bodies, Fuzes & Reloads

- 8933T Low Roll Training Body
- 8922T Low Roll II Training Body
- 1697T Training Fuze
- 1697TSC Training Fuze with Safety Clip
- 7008TC Distraction Device® Body Thread Cleaner (Not Shown)



PATENTED

TRAINING FUZE

CLEANING / MAINTENANCE



7009

DELUXE CLEANING / MAINTENANCE KIT

- Kit includes: nylon utility brush, cleaner handle, small bore brush, 15/16" wrench, large bore brush, tweezers, thread cleaner and Break Free® CLP® cleaner
- Complete cleaning kit for Distraction Device® units

7002

DD BODY CLEANING KIT

- Kit includes: 15/16" wrench, tweezers and brush
- Simple field expedient cleaning kit





STINGER® RUBBER BALL GRENADES

- Maximum effect device delivering three stimuli for psychological and physiological effects: rubber pellets, light and sound
- Widely used by law enforcement and corrections for crowd management and compliance
- Available with 32 Cal. or 60 Cal. Rubber Balls

OC CS



RUBBER BALL BLAST GRENADES

- Maximum effect device delivering three stimuli for psychological and physiological effects: light, sound and payload
- Widely used by law enforcement and corrections for crowd management and compliance

OC CN CS INERT

Stinger Rubber Ball Grenades

1087	60 Cal. Rubber Balls
1087SC	60 Cal. Rubber Balls with Safety Clip
1088	32 Cal. Rubber Balls with CS Payload
1088SC	32 Cal. Rubber Balls with CS Payload & Safety Clip
1089	32 Cal. Rubber Balls with OC Payload
1089SC	32 Cal. Rubber Balls with OC Payload & Safety Clip
1090	32 Cal. Rubber Balls
1090SC	32 Cal. Rubber Balls with Safety Clip

Rubber Ball Blast Grenades

1095	Rubber Ball Blast with OC
1095SC	Rubber Ball Blast with OC & Safety Clip
1096	Rubber Ball Blast with CN
1096SC	Rubber Ball Blast with CN & Safety Clip
1097	Rubber Ball Blast with CS
1097SC	Rubber Ball Blast with CS & Safety Clip
1098	Rubber Ball Blast with Inert Powder
1098SC	Rubber Ball Blast with Inert Powder & Safety Clip

12-Gauge Tactical

1210	12-Gauge Muzzle Bang/Launching Cartridge
3105	TKO 12-Gauge Breaching Round



TKO 12-GAUGE BREACHING ROUND

- Disintegrates on contact
- Instantly delivers full energy to door/lock hardware as it turns to dust
- Safe to use at close distances



12-GAUGE MUZZLE BANG / LAUNCHING CARTRIDGE

- Muzzle bang produces 170 dB of sound output
- Crowd control use for warning, intimidation or diversion
- Launching cartridge used in conjunction with 1370 Launching Cup
- Project Pocket Tactical Grenades further than hand throwing



8930
TYPE 3 MAGAZINE, DD TRANSPORT BOX

- ATF compliant type 3 magazine
- Constructed of 11-gauge steel
- Lined with ½" Masonite-type hardboard
- 1" side overlap of door
- Locking mechanism is compatible with a 3/8" diameter shackle
- Designed for two designated explosive devices



COMMAND
INITIATED RELOAD

- Command Initiated fuze for WallBanger™ or break and rake missions
- Produces 175 dB of sound output
- Produces 6-8 million candelas for 10 milliseconds
- Available in humidity-resistant versions

Command Initiated Reload

7030	Staging Spike (Not Shown)
7020	20' Thermo Tubing (Not Shown)
7001CI	Command Initiated 12-Gram Reload
8907CI	Command Initiated 4-Gram Reload (Not Shown)
8908CI	Command Initiated 8-Gram Reload (Not Shown)
7001CI-HH	Command Initiated 12G Reload, High Humidity
8907CI-HH	Command Initiated 4G Reload, High Humidity
8908CI-HH	Command Initiated 8G Reload, High Humidity



150944
1000' THERMO TUBE

- Thermo tube provides stand-off capabilities



7040
INITIATOR



7023
SPLICING TUBES (30 PACK)

7001CI
12-GRAM COMMAND INITIATED RELOAD



Renowned for its smooth single action and reliability, the Defense Technology® launchers are a recognized platform in the less lethal arena. Whether for crowd management, tactical deployment, or first responders, this family of launchers provides accuracy, quality and value.



**1425
40MM TACTICAL SINGLE
SHOT LAUNCHER**

- Lightweight (3.5lbs)
- Low cost
- Lateral single point sling mount
- Adjustable integrated front grip/light rail
- Picatinny top rail w/bead sight
- Single/Double action S&W trigger group
- Ambidextrous breech release
- 14" barrel
- Precision manufactured by Lewis Machine & Tool exclusively for Defense Technology
- NTOA member tested and recommended



Launchers	
1425	40mm Single w/ Expandable Stock
1426	40mm Single w/ Folding Stock
1427	40mm Single Pistol (No Stock)

Also available in 9" or 11" Barrels and Selected Colors for Cerakote™ Barrels or Stocks



**1440
40MM TACTICAL 4-SHOT LAUNCHER**

- Lightweight
- Low cost tactical 4-shot cylinder
- Pump action advance
- Quad rail
- Single/double action S&W trigger group with safety mechanism
- Ambidextrous breech release
- Precision manufactured by Lewis Machine & Tool exclusively for Defense Technology
- Includes all 2018 new design enhancements
- NTOA member tested and recommended
- Blast shield over forward cylinder



**NEW DESIGN ENHANCEMENTS
AS OF OCTOBER 2018**

- Slight material or coating changes for improved wear
- New mount plate for improved cylinder adjustment
- Enhanced drive mechanism for positive cylinder alignment
- Strengthened frame connections

Launchers	
1440	40mm Tactical 4-Shot



1415

37MM TACTICAL SINGLE LAUNCHER

- Lightweight (3.5lbs)
- Low cost
- Lateral single point sling mount
- Adjustable integrated front grip/light rail
- Picatinny top rail w/bead sight
- Single/Double action S&W trigger group
- Ambidextrous breech release
- 14" barrel
- Precision manufactured by Lewis Machine & Tool exclusively for Defense Technology
- NTOA member tested and recommended

Launchers

1415	37mm Single w/ Expandable Stock
1416	37mm Single w/ Folding Stock
1417	37mm Single Pistol (No Stock)

Also available in Selected Colors for Cerakote™ Barrels or Stocks



1820

LAUNCHER CARRY SYSTEM BAG

- Multi-function bag for grenadier officer
- Able to carry single or multi-launcher
- For tactical or mobile field force deployments
- Safariland® MLS, QLS, ELS Quick Attachment System compatible
- Choose one of two Accessory Pouch Kits (sold separately) to complete system

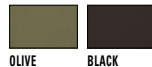
**LCS / Accessory Pouch Kits**

1821	Accessory Pouch Kit #1 Black
1831	Accessory Pouch Kit #1 Olive
1822	Accessory Pouch Kit #2 Black
1832	Accessory Pouch Kit #2 Olive
1820	Launcher Carry System Bag Black
1830	Launcher Carry System Bag Olive

1821

ACCESSORY POUCH KIT #1

- Gas mask pouch
- 32 – 37/40mm munitions pouches
- Two – grenade pouches

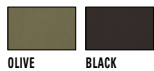

Military Munitions

The Defense Technology® brand continues to deliver reliable and effective tools to meet the challenges of asymmetrical warfare. From our military sponsored 40mm eXact iMPact™ round, to our smoke devices and 12-Gauge less lethal impact rounds, our products are manufactured to exacting specifications and quality standards. Defense Technology® is the leading provider of non-lethal munitions to the US Military, including 5 Type-classified products.



M1012/3021M
12-GAUGE NL POINT CONTROL CARTRIDGE

- Direct fire, short range 12-Gauge round
- Fin stabilized accuracy
- Specifically developed for routing, protecting chemical devices or targeting instigators

NSN# 1305-01-470-2405



M1013/3020M
12-GAUGE NL CROWD DISPERSAL CARTRIDGE

- Direct fire, short range 12-Gauge round
- Obtain compliance from a safe distance
- Specifically developed for routing, protecting chemical devices

NSN# 1305-01-470-2139



M1029/6095M
40MM NL CROWD DISPERSAL CARTRIDGE

- The custom 48 cal. rubber balls have increased weight and mass
- Direct/indirect fire munitions deliver massive pain compliance

NSN# 1310-01-475-0628



XM1116/3028M
12-GAUGE EXTENDED RANGE NL MARKING CARTRIDGE

- Accurately marks target at extended ranges
- Designed for locations with pre-set stand-off distances
- Drag Stabilized™ round delivers impressive energy at all effective ranges

NSN# 1305-01-536-1520



XM1091/6326M
40MM NL EXTENDED RANGE MARKING CARTRIDGE

- Direct fire munitions with payload options
- Unmatched accuracy out to 100 meters
- Crushing nose dampens blunt trauma while delivering payload

NSN# 1310-01-536-1536



M1030/3105M
12-GAUGE SHOTGUN BREACHING CARTRIDGE

- Disintegrates on contact
- Delivers enormous energy to locks/doors
- Safe to use at close distances
- Indoor/outdoor deployment

NSN# 1305-01-475-7440





M37/5846
DISPENSER, RIOT CONTROL AGENT, MID-SIZE

- Military version of a portable, high output aerosol system
- Accessory wands provide greater delivery options
- Refillable dispenser increases readiness in the field
- Indoor / outdoor deployable

NSN# 1040-01-463-0157



COLORED SMOKE GRENADES

- High volume pyrotechnic grenades
- Delivers large plumes of smoke
- Utilizes standard fuze
- Launching capabilities utilizing Defense Technology® launching cups
- Outdoor deployment

Colored Smoke Grenades

1064	Blue (NSN# 1330-01-541-4960)
1065	Green (NSN# 1330-01-541-4961)
1067	Red (NSN# 1330-01-541-6862)
1069	Yellow (NSN# 1330-01-541-4959)



XM104/1090M
STINGER® RUBBER BALL GRENADE

- An area deployment device
- Maximum stimulus overload via light, sound, and impact delivery





LESS LETHAL

MONADNOCK



The Monadnock® brand has a rich history of pioneering state-of-the-art American-made batons and training aids that has defined the way law enforcement professionals operate, train with and purchase batons for more than a half century. Our heritage and expertise focuses on our primary objective: providing the highest quality products to the men and women who depend on them every day.

Additionally, the Monadnock line includes the legendary Hiatt® brand of metal restraints, along with riot control suits and accessories in both hard and soft shell versions, offering a one-stop-shop for protective less lethal gear. There's a reason Monadnock products are the preferred choice of law enforcement professionals around the world – we simply build our products better.

AutoLock X3 HG Batons

The Monadnock® AutoLock® X3™ HG incorporates improvements found in the AutoLock X3™ series of batons, along with larger diameter shafts for those who prefer a baton with a stouter feel. Some of the features found in the X3 HG are an integrated nose guide for more efficient holstering and grip protection, improved positive locking design for reliability, a more stable feel with tightened tolerances and a corrosion-resistant finish and components. See our website for more information.



Made in the **USA**

9640

PATENTED

AUTOLOCK® X3™ HG

Model	Length	Weight	Finish	Grip Style	Tip Style	End Cap Style	Holder Plain
9643	19.75" (50cm)	17 oz. (.48 kg)	Black Electroless Nickel	Super Grip®	Safety Tip®	Standard	3080
9643W	19.75" (50cm)	16.47 oz. (.467kg)	Black Electroless Nickel	Super Grip	Safety Tip	Wedge	3080
9645	21" (53.34cm)	21 oz. (.597kg)	Black Electroless Nickel	Super Grip	Safety Tip	Standard	3080
9645W	21" (53.34cm)	20.59 oz. (.584kg)	Black Electroless Nickel	Super Grip	Safety Tip	Wedge	3080
9647	19.75" (50.16cm)	17 oz. (.48 kg)	Black Electroless Nickel	Foam Grip	Safety Tip	Standard	3080
9648	21" (53.34cm)	21 oz. (.597kg)	Black Electroless Nickel	Foam Grip	Power Safety Tip	Standard	3080
9647W	19.75" (50.16cm)	17 oz. (.48 kg)	Black Electroless Nickel	Foam Grip	Safety Tip	Wedge	3080
9648W	21" (53.34cm)	21 oz. (.597kg)	Black Electroless Nickel	Foam Grip	Power Safety Tip	Wedge	3080

AutoLock X3 Batons

The Monadnock® AutoLock® X3™ expandable baton improves its original positive locking design with notable improvements which include an updated cam and stainless steel ball bearing design which offers reliably consistent locking action. A more solid feel in the hand when performing or demonstrating techniques and a new smooth plastic nose on the baton handle for more efficient holstering and transition from the holster to the hand. New blackened electroless nickel finish improves corrosion resistance on the inside and outside of the baton. See our website for more information.



TIP OPTIONS

Available with either a Safety Tip®, 3xT Tactical Targeting Tip, or a Power Safety Tip® (shown here)

BLACK ELECTROLESS NICKEL FINISH

Improves corrosion resistance on the inside and outside of the baton

Made in the USA

SMOOTH PLASTIC NOSE

Featured on the baton handle for more efficient holstering and transition from the holster to the hand

IMPROVED POSITIVE LOCKING DESIGN

An updated cam and stainless steel ball bearing design offers reliably consistent locking action and more solid feel in the hand when performing or demonstrating techniques

END CAP OPTIONS

The patented AutoLock® baton features a push button in the end cap to easily close the baton after it has been deployed

Baton is shown with optional Wedge™ Baton Cap accessory

Hindi Baton Cap™ accessory also available

GRIP OPTIONS

Available with either Super Grip® (shown here) or firm Foam Grip



9870

PATENTED

AUTOLOCK® X3™

Model	Length	Weight	Finish	Grip Style	Tip Style	End Cap Style	Holder Plain	Holder Basketweave
9865	16" (40.64cm)	17 oz. (.48 kg)	Black Electroless Nickel	Foam Grip	Safety Tip®	Standard	3042	3642
9866	16" (40.64cm)	17 oz. (.48 kg)	Black Electroless Nickel	Super Grip®	Safety Tip	Standard	3042	3642
9867	16" (40.64cm)	17 oz. (.48 kg)	Black Electroless Nickel	Foam Grip	Safety Tip	Wedge	3042	3642
9868	16" (40.64cm)	17 oz. (.48 kg)	Black Electroless Nickel	Super Grip®	Safety Tip	Wedge	3042	3642
9869	18" (45.72cm)	19 oz. (.54 kg)	Black Electroless Nickel	Foam Grip	Power Safety Tip®	Standard	3042	3642
9870	18" (45.72cm)	19 oz. (.54 kg)	Black Electroless Nickel	Super Grip	Power Safety Tip	Standard	3042	3642
9871	18" (45.72cm)	19 oz. (.54 kg)	Black Electroless Nickel	Foam Grip	Power Safety Tip	Wedge	3042	3642

CONCEALABLE ARMOR | TACTICAL ARMOR | COMMUNICATIONS | DUTY GEAR/HOLSTERS | PROTECTIVE GEAR | FIREARMS ACCESSORIES | LESS LETHAL | PERFORMANCE APPAREL | SURVIVABILITY SYSTEMS | FORENSICS | ARMOR SYSTEMS | TRAINING ACADEMY



AutoLock X3 Batons

AUTOLOCK® X3™ (CONTINUED)

Model	Length	Weight	Finish	Grip Style	Tip Style	End Cap Style	Holder Plain	Holder Basketweave
9872	18" (45.72cm)	19 oz. (.54 kg)	Black Electroless Nickel	Super Grip®	Power Safety Tip®	Wedge	3042	3642
9850	21" (53.34cm)	19 oz. (.54 kg)	Black Electroless Nickel	Foam Grip	Safety Tip®	Standard	3030	3630
9851	21" (53.34cm)	19 oz. (.54 kg)	Black Electroless Nickel	Super Grip	Safety Tip	Standard	3030	3630
9852	21" (53.34cm)	19 oz. (.54 kg)	Black Electroless Nickel	Foam Grip	Safety Tip	Wedge	3030	3630
9853	21" (53.34cm)	19 oz. (.54 kg)	Black Electroless Nickel	Super Grip	Safety Tip	Wedge	3030	3630
9860	22" (55.88cm)	22 oz. (.62 kg)	Black Electroless Nickel	Foam Grip	Power Safety Tip	Standard	3034	3634
9861	22" (55.88cm)	22 oz. (.62 kg)	Black Electroless Nickel	Super Grip	Power Safety Tip	Standard	3034	3634
9862	22" (55.88cm)	22 oz. (.62 kg)	Black Electroless Nickel	Foam Grip	Power Safety Tip	Wedge	3034	3634
9863	22" (55.88cm)	22 oz. (.62 kg)	Black Electroless Nickel	Super Grip	Power Safety Tip	Wedge	3034	3634
9873	26" (66.04cm)	24 oz. (.68 kg)	Black Electroless Nickel	Foam Grip	Power Safety Tip	Standard	3056	3656
9874	26" (66.04cm)	24 oz. (.68 kg)	Black Electroless Nickel	Super Grip	Power Safety Tip	Standard	3056	3656
9875	26" (66.04cm)	24 oz. (.68 kg)	Black Electroless Nickel	Foam Grip	Power Safety Tip	Wedge	3056	3656
9876	26" (66.04cm)	24 oz. (.68 kg)	Black Electroless Nickel	Super Grip	Power Safety Tip	Wedge	3056	3656

AUTOLOCK® (HEAVY GAUGE) BATONS

Made in the USA

BLACK CHROME FINISH

TIP OPTIONS
Available with either Safety Tip® or Power Safety Tip® (shown here)

END CAP OPTIONS
The patented AutoLock® baton features a push button in the end cap to easily close the baton after it has been deployed

Choose from the optional Wedge™ Baton Cap or Hindi Baton Cap™ accessories for enhanced baton retention

GRIP OPTIONS
Available with either Super Grip® or firm Foam Grip (shown here)



9630

PATENTED

AUTOLOCK BLACK CHROME FINISH

Model	Length	Weight	Finish	Grip Style	Tip Style	Holder Plain
9630	22" (55.88cm)	21 oz. (.57kg)	Black Chrome	Foam Grip	Power Safety Tip®	3084
9641R	19.75" (50cm)	18 oz. (.51kg)	Black Chrome	Super Grip®	Safety Tip®	3080

AutoLock II Baton



The AutoLock® II baton features patented AutoLock technology with a newly designed cam and stainless steel ball bearing which improves the locking action and baton stability.

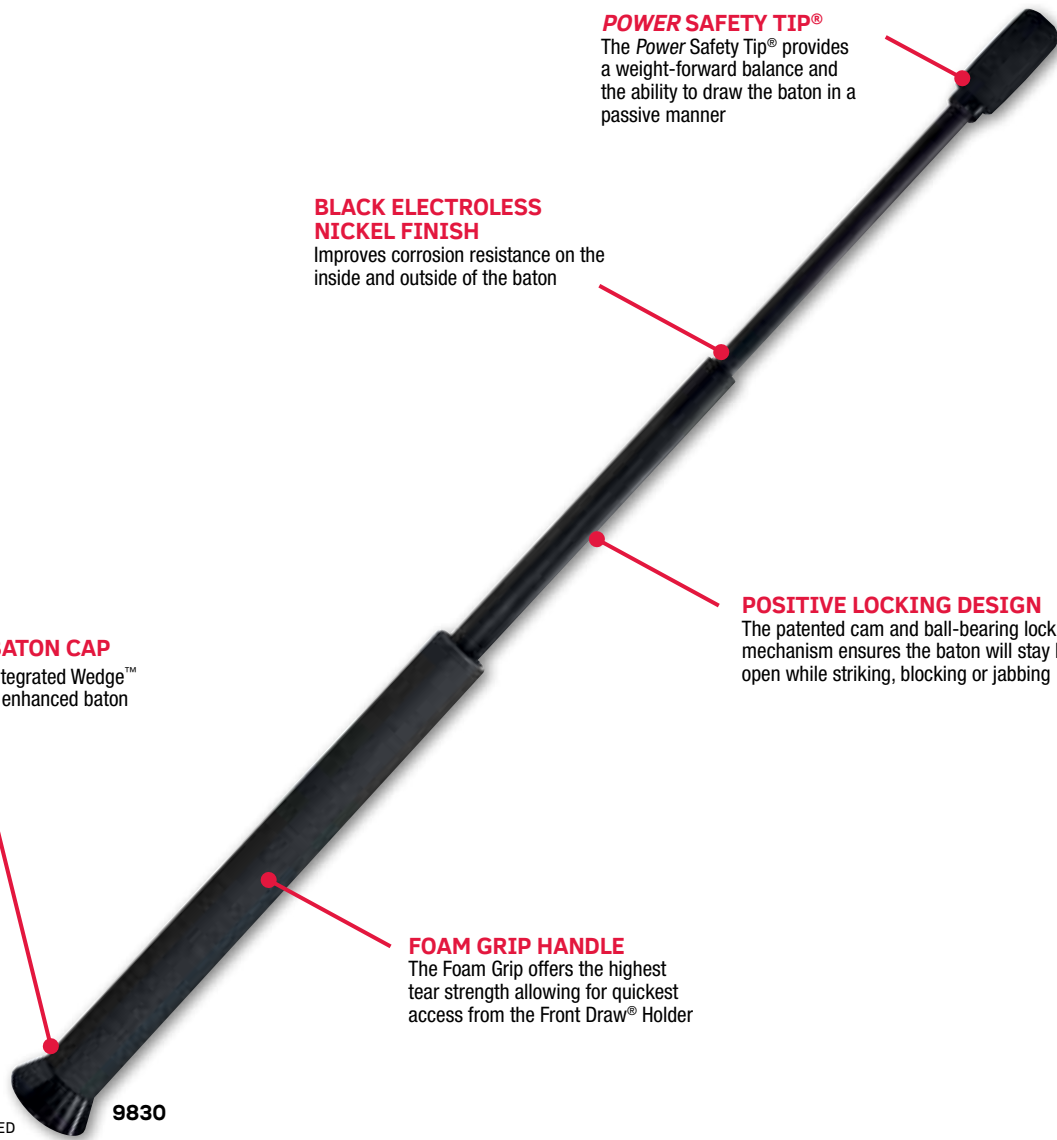

POWER SAFETY TIP®
The Power Safety Tip® provides a weight-forward balance and the ability to draw the baton in a passive manner

BLACK ELECTROLESS NICKEL FINISH
Improves corrosion resistance on the inside and outside of the baton

Made in the **USA**

WEDGE™ BATON CAP
Features an integrated Wedge™ Baton Cap for enhanced baton retention

POSITIVE LOCKING DESIGN
The patented cam and ball-bearing locking mechanism ensures the baton will stay locked open while striking, blocking or jabbing

FOAM GRIP HANDLE
The Foam Grip offers the highest tear strength allowing for quickest access from the Front Draw® Holder

PATENTED **9830**

AUTOLOCK® II							
Model	Length	Weight	Finish	Grip Style	Tip Style	Holder Plain	Holder Basketweave
9830	23" (58.42cm)	24.8 oz. (.70kg)	Black Electroless Nickel	Foam Grip	Power Safety Tip®	3034*	3634

*DESIGNATE 45 DEGREE LOCKING HOLDER WITH /L AFTER PART NUMBER

CONCEALABLE ARMOR | TACTICAL ARMOR | COMMUNICATIONS | DUTY GEAR/HOLSTERS | PROTECTIVE GEAR | ACCESSORIES | LESS LETHAL | PERFORMANCE APPAREL | SURVIVABILITY SYSTEMS | FORENSICS | ARMOR SYSTEMS | TRAINING ACADEMY

AutoLock Batons



TIP OPTIONS

Available with either a Safety Tip®, 3xT Tactical Targeting Tip, or a Power Safety Tip® (shown here)

FINISH OPTIONS

Available with Nickel (shown here) or Black Chrome

Made in the **USA**

END CAP OPTIONS

The patented AutoLock® baton features a push button in the end cap to easily close the baton after it has been deployed

Choose from the optional Wedge™ Baton Cap or Hindi Baton Cap™ accessories for enhanced baton retention

POSITIVE LOCKING DESIGN

The patented cam and ball-bearing locking mechanism ensures the baton will stay locked open while striking, blocking or jabbing

GRIP OPTIONS

Available with either firm Foam Grip (shown here) or Super Grip®

PATENTED

9230

AUTOLOCK®

Model	Length	Weight	Finish	Grip Style	Tip Style	Holder Plain	Holder Basketweave
9170	18" (45.72cm)	19 oz. (.54kg)	Black Chrome	Foam Grip	Power Safety Tip®	3042	3642
9172	18" (45.72cm)	19 oz. (.54kg)	Black Chrome	Super Grip®	Power Safety Tip	3042	3642
9120	21" (53.34cm)	19 oz. (.54kg)	Black Chrome	Foam Grip	Safety Tip®	3030	3630
9141	21" (53.34cm)	19 oz. (.54kg)	Black Chrome	Super Grip	Safety Tip	3030	3630
9130	22" (55.88cm)	22 oz. (.62kg)	Black Chrome	Foam Grip	Power Safety Tip	3034	3634
9152	22" (55.88cm)	22 oz. (.62kg)	Black Chrome	Super Grip	Power Safety Tip	3034	3634
9121	26" (66.04cm)	24 oz. (.68kg)	Black Chrome	Foam Grip	Power Safety Tip	3056	3656
9146	26" (66.04cm)	24 oz. (.68kg)	Black Chrome	Super Grip	Power Safety Tip	3056	3656
9220	21" (53.34cm)	19 oz. (.54kg)	Nickel	Foam Grip	Safety Tip	3030*	3630
9241	21" (53.34cm)	19 oz. (.54kg)	Nickel	Super Grip	Safety Tip	3030*	3630
9230	22" (55.88cm)	22 oz. (.62kg)	Nickel	Foam Grip	Power Safety Tip	3034*	3634
9252	22" (55.88cm)	22 oz. (.62kg)	Nickel	Super Grip	Power Safety Tip	3034*	3634

DESIGNATE 45 DEGREE LOCKING HOLDER WITH /L AFTER PART NUMBER

Classic Friction Lock Batons

Classic Friction
LOCK BATONS

STANDARD STEEL TIP

FINISH OPTIONS

Mariner Series available in Nickel or Detective® Series available in Black Chrome (shown here)

Made in the
USA

END CAP OPTIONS

Standard Bore Guide End Cap centers the tip and shaft over an internal retention spring. Due to the reliable design of these batons, repairs are rarely needed

Choose from the optional Wedge™ Baton Cap or Hindi Baton Cap™ accessories for enhanced baton retention

FRICTION LOCKING TECHNOLOGY

The use of precision dies forms concentric tapers which significantly improve the lock open function of Monadnock batons

FOAM GRIP

Offers the highest tear strength allowing for quickest access from the Front Draw Holder

2521

CLASSIC FRICTION LOCK

Model	Length	Weight	Finish	Grip Style	Tip Style	Holder Plain*	Holder Basketweave*
2516	16" (40.64cm)	14 oz. (.40kg)	Black Chrome	Foam Grip	Standard	3025	3625
2521	21" (53.34cm)	17 oz. (.48kg)	Black Chrome	Foam Grip	Standard	3027	3627
2562	21" (53.34cm)	17 oz. (.48kg)	Black Chrome	Super Grip®	Standard	3027	3627
2526	26" (66.04cm)	20 oz. (.57kg)	Black Chrome	Foam Grip	Standard	3027/3032	3627/3632
2530	21" (53.34cm)	17 oz. (.48kg)	Nickel	Foam Grip	Standard	3027	3627
2534	26" (66.04cm)	20 oz. (.57kg)	Nickel	Foam Grip	Standard	3027/3032	3627/3632

*360° LOCKING HOLDER; 45° LOCKING HOLDERS ALSO AVAILABLE



PATROL KITS

- Added savings with three amazing tools in one complete package
 - AutoLock® 22" Black Chrome Expandable Baton
 - Bright hard coat Hindi Baton Cap™
 - Front Draw® Holder made of durable polycarbonate with a clip-on attachment
- Choose from 360° or 45° swivel locking holder models
- Hindi Baton Cap™ adds baton retention and officer confidence
- Choose Foam Grip or Super Grip®
- Includes Power Safety Tip® providing larger, more effective striking force



Made in the USA



*Comes with Patrol Kit only



AUTOLOCK® PATROL KIT

Description	360° Part No.	45° Part No.	Grip	End Cap
AutoLock® 22", BC, Power Safety Tip®, Hindi Baton Cap™	9330	9334	Foam Grip	Hindi Baton Cap
AutoLock 22", BC, Power Safety Tip, Hindi Baton Cap	9352	9354	Super Grip®	Hindi Baton Cap

DUTY KITS

- Save money purchasing these popular baton and holder sets!
 - AutoLock® 22" Baton w/Power Safety Tip®
 - Front Draw® 360° swivel locking holder made of durable polycarbonate with a clip-on attachment
- Choose Foam Grip or Super Grip®
- Includes Power Safety Tip providing larger, more effective striking force

AUTOLOCK® DUTY KIT

Description	360° Part No.	Grip	End Cap
AutoLock® 22", BC, Power Safety Tip®	9530	Foam Grip	Standard Cap
AutoLock 22", BC, Power Safety Tip	9552	Super Grip®	Standard Cap

*SAME POPULAR KIT AS ABOVE WITH THE EXCLUSION OF THE HINDI BATON CAP, INCLUDES BATON AND HOLDER ONLY

Baton Kits

Classic Friction **LOCK** BATONS

Made in the **USA**

PATROL KITS

- Added savings with three amazing tools in one complete package
 - 21" and 26" Classic Friction Lock Black Chrome Expandable Baton
 - Standard Steel Tip
 - Bright hard coat Hindi Baton Cap™
 - Polycarbonate Front Draw® Holder
- Clip-on polycarbonate holder—choose from 360° or 45° swivel locking models
- Hindi Baton Cap™ adds baton retention and officer confidence
- Choose Foam Grip or Super Grip®



*Comes with Patrol Kit only



CLASSIC FRICTION LOCK PATROL KIT

Description	360° Part No.	45° Part No.	Grip	End Cap
Friction Lock 21" BC, Hindi Baton Cap	2620	2680	Foam Grip	Hindi Baton Cap
Friction Lock 26" BC, Hindi Baton Cap	2630	2690	Foam Grip	Hindi Baton Cap

DUTY KITS

- Save money purchasing these popular baton and holder sets!
 - 21" and 26" Friction Lock Baton w/Standard Tip
 - Front Draw® 360° swivel locking holder made of durable polycarbonate with a clip-on attachment
- Choose Foam Grip or Super Grip®

CLASSIC FRICTION LOCK DUTY KIT

Description	360° Part No.	Grip	End Cap
Friction Lock 21", Standard Tip	2721	Foam Grip	Standard Cap
Friction Lock 26", Standard Tip	2726	Foam Grip	Standard Cap

*SAME POPULAR KIT AS ABOVE WITH THE EXCLUSION OF THE HINDI BATON CAP, INCLUDES BATON AND HOLDER ONLY



CONCEALABLE ARMOR | TACTICAL ARMOR | COMMUNICATIONS | DUTY GEAR/HOLSTERS | PROTECTIVE GEAR | ACCESSORIES | FIREARMS | LESS LETHAL | PERFORMANCE APPAREL | SURVIVABILITY SYSTEMS | FORENSICS | ARMOR SYSTEMS | TRAINING ACADEMY

PR-24 Side-Handle Batons

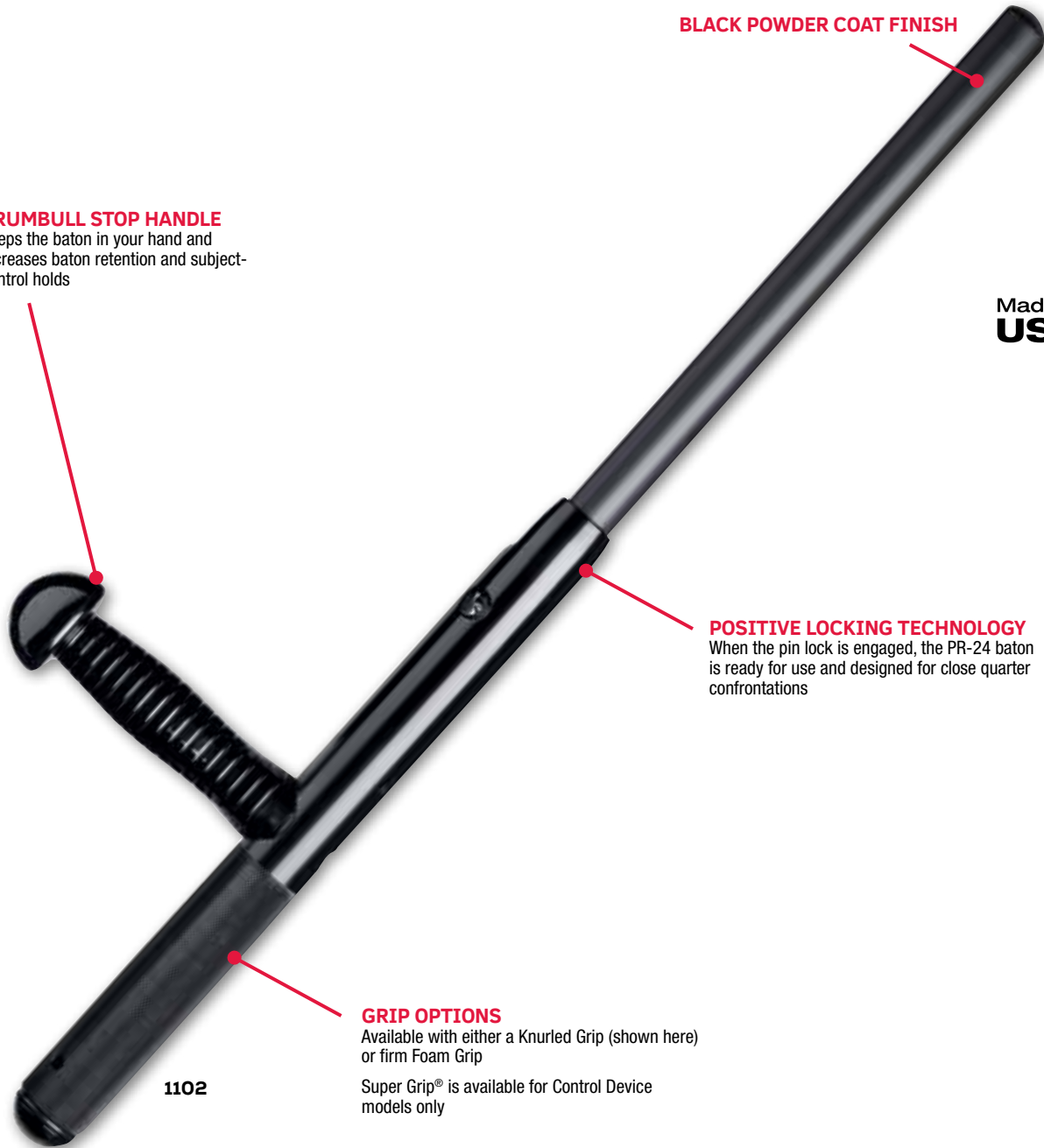

BLACK POWDER COAT FINISH

TRUMBULL STOP HANDLE
keeps the baton in your hand and increases baton retention and subject-control holds

Made in the
USA

POSITIVE LOCKING TECHNOLOGY
When the pin lock is engaged, the PR-24 baton is ready for use and designed for close quarter confrontations

GRIP OPTIONS
Available with either a Knurled Grip (shown here) or firm Foam Grip
Super Grip® is available for Control Device models only

1102



1121



PR-24® BLACK ANODIZED

Part No.	Model	Type	Length	Weight	Diameter	Grip Style	Shaft Finish	Holder Plain
1100	PR-24X	Expandable	24" (60.96cm)	24 oz. (.68kg)	1.25" (3.2cm)	Knurled	Black Polycarbonate	3010
1101	PR-24XTS	Expandable	24" (60.96cm)	24 oz. (.68kg)	1.25" (3.2cm)	Knurled	Black Polycarbonate	3010
1102	PR-24FX	Expandable	24" (60.96cm)	31 oz. (.88kg)	1.25" (3.2cm)	Knurled	Black Powder Coat	3010
1105	PR-24NX	Expandable	24" (60.96cm)	31 oz. (.88kg)	1.25" (3.2cm)	Foam	Black Powder Coat	3010
1121	Control Device 21	Expandable	21" (53.34cm)	16 oz. (.45kg)	1" (2.5cm)	Super Grip®	Black Powder Coat	3015
1124	Control Device 24	Expandable	24" (60.96cm)	18 oz. (.51kg)	1" (2.5cm)	Super Grip	Black Powder Coat	3015
1121-2	Control Device 21*	Expandable	21" (53.34cm)	17.42 oz. (.494kg)	1" (2.5cm)	Super Grip®	Black Anodized Aluminum	3015
1124-2	Control Device 24*	Expandable	24" (60.96cm)	19.54 oz. (.554kg)	1" (2.5cm)	Super Grip	Black Anodized Aluminum	3015

*NEXT GENERATION CONTROL DEVICE REDESIGNED WITH AN IMPROVED SHOCK ABATEMENT SYSTEM FOR GREATER LONGEVITY

1000



PR-24® BLACK POLYCARBONATE

Part No.	Model	Type	Length	Weight	Diameter	Grip Style	Holder Plain	Holder Basketweave
1000	PR-24STS	Rigid	24" (60.96cm)	24 oz. (.68kg)	1-1/4" (3.2cm)	Grenade	3010	N/A
1001	PR-24S	Rigid	24" (60.96cm)	24 oz. (.68kg)	1-1/4" (3.2cm)	Grenade	3010	N/A

Expandable Straight Batons

SX & MX SERIES

- Uses a pin and spring to create a mechanical (or positive locking) mechanism that keeps baton open and makes it easy to close
- Baton locks in handle and may be locked in the extended open position with the push of a button
- Weight-forward shaft technology for increased “knock-down” power
- Aluminum polycarbonate composition impervious to rusting
- Model 2502: 24” closed and expands to 36” in the open position; can be used as a straight baton closed and a riot baton in the open position
- SX Baton models available in 1.25” diameter; MX Baton models available in 1” diameter

Made in the
USA

2502



SX EXPANDABLE STRAIGHT BATONS

Part No.	Model	Length	Weight	Diameter	Material	Finish	Grip Style	Holder Plain
2502	SX-24/36 Riot Baton	36" (91.44cm)	24 oz. (.68kg)	1.25" (3.2cm)	Aluminum/Polycarbonate	Black	Knurled	3011
2503	SX-24	24" (60.96cm)	19 oz. (.54kg)	1.25" (3.2cm)	Aluminum/Polycarbonate	Black	Foam	3011

2506



MX EXPANDABLE STRAIGHT BATONS

Part No.	Model	Length	Weight	Diameter	Material	Finish	Grip Style	Holder Plain	Holder Basketweave
2506	MX-21	21" (53.34cm)	13 oz. (.37kg)	1" (2.54cm)	Aluminum	Black	Foam	3006	3606
2507	MX-24	24" (60.96cm)	14 oz. (.40kg)	1" (2.54cm)	Aluminum	Black	Foam	3006	3606

RIGID BATONS

2006



PLP BATONS

- Polycarbonate material provides an extremely durable finish
- Stronger in cold weather and does not warp in heat
- Excellent impact resistance
- Weather and dent resistant, and won't warp, peel or splinter
- 1" diameter

PLP BATONS

Part No.	Model	Length	Weight	Diameter	Material	Finish	Grip Style	Holder Plain	Holder Basketweave
2006	PLP-24	24" (60.96cm)	14.4 oz. (.41kg)	1" (2.5cm)	Polycarbonate	Black	Foam	3006	3606
2007	PLP-26	26" (66.04cm)	15 oz. (.43kg)	1" (2.5cm)	Polycarbonate	Black	Foam	3006	3606
2009	PLP-36	36" (91.44cm)	20.8 oz. (.59kg)	1" (2.5cm)	Polycarbonate	Black	N/A	3006	3606

Rigid Batons

2015



MP BATONS

- Polycarbonate material provides an extremely durable finish
- 1 ¼" diameter; choose from a variety of grips
- Stronger in cold weather and will not warp in heat
- Excellent impact resistance
- Resists denting and won't splinter
- 24", 26", 36" (60.96cm, 66.04cm, 91.44cm)

Made in the USA

MP BATONS

Part No.	Model	Length	Weight	Diameter	Material	Finish	Grip Style	Holder
2001	MP24	24" (60.96cm)	20 oz. (.57kg)	1.25" (3.2cm)	Polycarbonate	Black	Knurled	3011
2002	MP26	26" (66.04cm)	21.6 oz. (.61kg)	1.25" (3.2cm)	Polycarbonate	Black	Knurled	3011
2003	MP26 (LAPD Style, No Grip)	26" (66.04cm)	21.6 oz. (.61kg)	1.25" (3.2cm)	Polycarbonate	Black	Plain	3011
2004	MP36 Riot Baton	36" (91.44cm)	30 oz. (.85kg)	1.25" (3.2cm)	Polycarbonate	Black	Knurled	3011
2011	36" Riot Baton	36" (91.44cm)	19 oz. (.54kg)	1.25" (3.2cm)	Thermoplastic	Black	Grenade	3011
2015	MPNYPD26 (Thong/Grommet)	26" (66.04cm)	19 oz. (.54kg)	1.25" (3.2cm)	Polycarbonate	Black	Foam	3011
2154	GG-36	36" (91.44cm)	19 oz. (.54kg)	1.25" (3.2cm)	Polycarbonate	Black	Grenade	3011

2906 / 2915



PERSUADER™

- Lightweight and compact – 5 1/2" in length
- Grooved black polycarbonate with convenient key ring attachment
- Last chance self-defense tool
- Model 2915 offered in aluminum, black anodized

WOOD BATONS

- Traditional design
- Made from a natural hardwood for long-lasting service
- Available with thong

2800



WOOD BATONS

Part No.	Model	Length	Weight	Diameter	Material	Finish	Grip Style	Holder
2800	2800	36" (91.44cm)	18 oz. (.51kg)	1.25" (3.2cm)	Hardwood	Natural	Ring	Ring
2800 /B	2800	36" (91.44cm)	18 oz. (.51kg)	1.25" (3.2cm)	Hardwood	Black	Ring	Ring
2801	2801	26" (66.04cm)	13 oz. (.37kg)	1.25" (3.2cm)	Hardwood	Black	Plain	Ring



6001

D-JAMMER™ FIREARM CLEANING TOOL

- Easily and quickly dislodges jammed shells
- Clears jammed semi-automatic magazines and revolver cylinders
- Can also be used as a Persuader

CONCEALABLE ARMOR | TACTICAL ARMOR | COMMUNICATIONS | DUTY GEAR/HOLSTERS | PROTECTIVE GEAR | ACCESSORIES | FIREARMS | LESS LETHAL | PERFORMANCE APPAREL | SURVIVABILITY SYSTEMS | FORENSICS | ARMOR SYSTEMS | TRAINING ACADEMY

Baton Accessories

Monadnock® offers a wide selection of baton holders in different styles and materials to fit the needs of each of its batons. Safariland® and Bianchi® Duty Gear also offer baton holders for several Monadnock baton styles.

Made in the USA

See website for full list of models



3011



3627



3034

PATENTED



3800

FRONT DRAW®

BATON HOLDER

- Designed with clip-on backs specifically for easy removal from a duty belt
- Made from durable polycarbonate, all holders feature a molded tension spring for baton security
- Choose from three models:
 - 360° with 8 locking position
 - 45° with 2 locking positions
 - 90° swivel providing the ability to lock at any preferred angle
- Fits 2.25" (58mm) belt widths

See website for full list of models



3774



FRONT

SIDE-HANDLE BATON HOLDER

- Designed with the Safariland® 774BL belt clip and retention clip for cross draw carry (right hand model will sit on left side of body and left hand model sits on right side of body)
- 90° swivel provides the ability to lock at any preferred angle
- Available for both PR-24® and Control Device batons in both left- and right-handed versions
- Unique retention device secures baton by side-handle for security
- Fits 2.25" belt widths



3035

BATON HOLDER

- Low-profile design
- Fits most 1 1/16" expandable batons
- User-adjustable design to customize baton retention

CD AND PR HOLDER MODELS CLIP ON BACK NO STRAP

Part No.	Description	Length	Weight	Baton Diameter	Material	Finish	Worn On
3770	Expandable Baton Holder	3.25" (8.26cm)	1.6 oz. (.045kg)	1" (2.54cm)	STX	Tactical	Left
3771	Expandable Baton Holder	3.25" (8.26cm)	1.6 oz. (.045kg)	1" (2.54cm)	STX	Tactical	Right
3772	Expandable Baton Holder	3.25" (8.26cm)	1.6 oz. (.045kg)	1" (2.54cm)	STX	Basket Weave	Left
3773	Expandable Baton Holder	3.25" (8.26cm)	1.6 oz. (.045kg)	1" (2.54cm)	STX	Basket Weave	Right
3774	Expandable Baton Holder	3.25" (8.26cm)	1.6 oz. (.045kg)	1.25" (3.17cm)	STX	Tactical	Left
3775	Expandable Baton Holder	3.25" (8.26cm)	1.6 oz. (.045kg)	1.25" (3.17cm)	STX	Tactical	Right
3776	Expandable Baton Holder	3.25" (8.26cm)	1.6 oz. (.045kg)	1.25" (3.17cm)	STX	Basket Weave	Left
3777	Expandable Baton Holder	3.25" (8.26cm)	1.6 oz. (.045kg)	1.25" (3.17cm)	STX	Basket Weave	Right

BATON CAPS



6210



6213

PATENTED



Friction Lock style



AutoLock style

PATENTED

HINDI BATON CAP™

- Offers enhanced baton retention and maximum striking power during physical altercations while being safer to the suspect without limiting the use of force

WEDGE™ BATON CAP

- This tapered design offers a natural grip for maximum baton retention while in the field or performing techniques in a training environment





Monadnock batons feature a wide variety of grips, tips and finishes to allow you to choose the tool that best fits your duty requirements.

TIPS



Standard Steel Tip
Allows for opening the baton in a high-profile manner; may gain psychological advantage for officer over subject.



Safety Tip®
Reduces sharp edges; urethane covering allows passive drawing of the baton.



Power Safety Tip®
Engineered to put more weight forward to better balance the baton in the hand and improve kinetic energy transfer at the moment of impact. The larger tip surface may turn a subject's pockets inside out, reducing the risk of getting stuck with sharp objects.



3xT Tactical Training Targeting Tip
Featuring the *Power Safety Tip* that helps criminal justice professionals improve their striking skill because they can clearly see the track of the baton's tip during demonstrations, practice and/or in the street. Lime green only.

GRIPS



Foam Grip
Offers the highest tear strength and allows quick access from the Front Draw® Holder.



Super Grip®
The fluted surface texture provides excellent baton retention in and out of the holder.



Knurled Grip
The knurled grip enhances baton retention while performing strikes, blocks or jabbing techniques.



Grenade Grip
Offers a ridged handle design for a sure grip.

FINISHES



Black Chrome



Polycarbonate



Nickel



Black Anodized Aluminum



Blackened Electroless Nickel

Training Aids

The finest training aids for the finest products. Proper training with the right tools makes all the difference. Our line of practical training aids significantly enriches learning during practice exercises. Resistance training builds confidence. Our Universal Training Bags and foam batons can be used during dynamic or scenario training to improve skills and reduce the risk of injury.

Training batons are recommended for use with static dynamic baton training



5106



5107



5101



5102



5103

ULTIMATE STRAIGHT TRAINING BATON

- Durable DuPont™ nylon cover
- 1/2" closed high-density cell foam
- Tip dipped in vinyl
- Energy absorbing construction allows scenarios to be performed with greater ease and comfort

ULTIMATE SIDE-HANDLE TRAINING BATON

- Durable DuPont nylon cover
- 1/2" closed high-density cell foam
- Tip dipped in vinyl
- Energy absorbing construction allows scenarios to be performed with greater ease and comfort

SIDE-HANDLE TRAINING BATON

- High-density, closed-cell white foam training side handle baton
- Flexible for lower impact while practicing techniques

MFTB STRAIGHT TRAINING BATON

- Lightweight, open-cell foam
- For performing dynamic training exercises
- Economical

STRAIGHT TRAINING BATON

- High-density, closed-cell foam white training baton
- Flexible design for lower impact while practicing techniques

Model	Description	Length	Weight	Diameter
5101	Side-Handle Training Baton	24" (60.96 cm)	10 oz.	1.25" (3.175cm)
5102	Straight Training Baton	24" (60.96 cm)	4.65 oz.	1.375" (3.49cm)
5103	Straight Training Baton	24" (60.96 cm)	9.4 oz.	1.25" (3.175cm)
5105	Straight Training Baton	36" (91.44 cm)	9.8 oz.	1.25" (3.175cm)
5106	Ultimate Straight Training Baton	24" (60.96 cm)	9 oz.	2" (5.08cm)
5107	Ultimate Side-Handle Training Baton	24" (60.96 cm)	17 oz.	2.25" (5.61cm)

TRAINING BATONS ARE RECOMMENDED FOR USE WITH STATIC DYNAMIC BATON TRAINING



5006 UNIVERSAL TRAINING BAG 2 (UTB2)

- Features a high-tech Force Deceleration Core to dissipate training blows from knees, elbows, fists or training-baton strikes with ease and comfort
- Offers six hand positions to create multiple target positions around the human body, which develops target acquisition and application skills for more realism in training
- Easy to carry and store



5002 UNIVERSAL TRAINING BAG (UTB)

- Helps bridge the gap between static and dynamic movement in training
- Tactically used for baton physical encounter training:
 - Simulated training scenarios
 - Punching, kicking, elbowing, kneeing, etc.
 - Action-reaction response drills, including unarmed self-defense training and baton training
- Easy to carry and store

HARD SHELL RIOT CONTROL SYSTEM

The cost-effective, lightweight ExoTech® System offers hard-shell protection without sacrificing mobility and can be quickly donned or doffed with ease for rapid riot control response. Each piece of the ExoTech system fastens and adjusts quickly with durable polypropylene and elastic straps with hook and loop closures, allowing a custom fit for a wide variety of body types. The contour-molded polyethylene outer shell provides substantial protection from blunt force trauma.



ECB100 HARD-SHELL TORSO PROTECTOR

HUEX100 HYDRATION SYSTEM

EFP150 HARD-SHELL FOREARM GUARD

ETP200 HARD-SHELL THIGH & GROIN PROTECTOR

TS70 HARD-SHELL SHIN GUARD

ECB100

UPPER BODY/SHOULDER

- Polyethylene outer shell
- L2500 EVA foam & 3mm polyethylene plate chest/back/arm padding
- EVA foam & polyethylene plate shoulder padding

OPTIONAL REFLECTIVE LABELS



6595 POLICE



6596 SHERIFF



6597 CORRECTIONS



TS70 HARD-SHELL SHIN GUARD

- Hard polyethylene shells with interior leg-brace support can safely withstand a substantial blow to the leg from non-ballistic weapons or flying debris
- Includes adjustable, removable foot protector
- Non-reflective outer surface



EFP150 FOREARM

- Polyethylene outer shell
- EVA foam & polyurethane sponge padding
- Mesh inner lining



ETP200 THIGH & GROIN SECTIONS

- Polyethylene outer shell
- Laminated EVA foam & L2500 EVA foam
- Mesh inner lining



HUEX100 HYDRATION SYSTEM

- Includes bladder and carrier
- High-quality, odorless bladder
- 70 oz. capacity
- Features Bite Me™ revolutionary flow control valve for 360° activation and leak free operation
- Compatible with both ExoTech® and Centurion™ Riot Control Systems



KNP100 NECK PROTECTOR

- Offers heat, cut and abrasion-resistant protection for throat, neck and larynx
- Designed to be worn with Centurion™ and / or ExoTech® riot suits
- Comfortable stretch knit construction
- Made with Kevlar® fiber



KS19 PROTECTIVE SLEEVES

- Resists bites, scratches or cuts from sharp objects
- Design provides a moderate amount of heat, abrasion and cut protection
- Excellent for deploying flash bangs
- 2-ply, 7oz. Kevlar® fiber



Based on our ExoTech® line of riot suits, the MOLLE loop option allows for greater payload, allowing an officer to carry gear and accessories required for crowd management situations.



FRONT



BACK

**ETP200/MOLLE
MOLLE THIGH AND
GROIN BELT**

- Provides thigh and groin protection
- MOLLE webbing for versatile payload options
- Sizes: Small, Medium and Large



**ECB100/MOLLE VEST
MOLLE TORSO
ATTACHMENT**

- MOLLE webbing to carry more payload
- Attaches to ECB100 Hard-Shell Upper Body
- Sizes: Small, Medium, Large, X-Large and XX-Large

NEW



**AP
EXOTECH ARM
PROTECTION KIT**

- Attaches to any PROTECH® vest, not included
- 3mm polyethylene hard shell for protection from blunt force trauma
- Moisture-wicking fabric for comfort
- EVA foam & polyurethane sponge padding
- Riveted polypropylene connector straps
- Commercial-grade elastic adjustment straps with hook and loop fasteners
- Reflective label compatible

Shown with PROTECH plate rack, not included



SOFT SHELL RIOT CONTROL SYSTEM

This protective piece is a must for riot control and cell extractions, effectively protecting the torso and shoulders from blunt force trauma. The lightweight, cellular pad design provides ample protection and allows excellent mobility. Includes attachment points for our HUEX100 Hydration System.



CPX2500 SOFT-SHELL
TORSO PROTECTOR

FP100 SOFT-SHELL
FOREARM PROTECTOR

GP300 SOFT-SHELL
GROIN PROTECTOR

TS70 HARD-SHELL
SHIN GUARD

OPTIONAL REFLECTIVE LABELS

POLICE**6595 POLICE****SHERIFF****6596 SHERIFF****CORRECTIONS****6597 CORRECTIONS**

- Hook and loop compatible
- Dimensions: 3" W x 8 11/16" L x 1/8" D (7.6cm x 22.1cm x .3cm)
- Not shown: State (6772)

**TS70****HARD-SHELL SHIN GUARD**

- Hard polyethylene shells with interior leg-brace support can safely withstand a substantial blow to the leg from non-ballistic weapons or flying debris
- Includes adjustable, removable foot protector
- Non-reflective outer surface

**GP300****CENTURION™ GROIN PROTECTOR**

- Hook and loop fasteners provide groin protection without hindering mobility
- Construction consists of durable EVA foam pads with sponge foam covering on the inside for comfort and surrounded by a black polyester mesh rigging
- Fastens easily to the CPX2500 with 1" elastic and non-elastic straps
- Weight: 8 oz.
- One size fits all

**CPX2500****CENTURION™ UPPER BODY AND SHOULDER PROTECTION**

- Torso protection consists of durable EVA foam with 7mm sponge foam on the interior for comfort
- Shoulder pad features hard-shell plastic plates with durable foam padding
- Will safely absorb blows delivered from blunt objects

**TPX200****CENTURION™ THIGH/GROIN PROTECTION SYSTEM**

- Specifically designed for blunt trauma protection during riot control situations
- Multilayer protective design with 420-denier outer fabric covers hip and thigh areas and has an adjustable and removable groin protector
- Provides excellent shock-absorbing protection, and is flexible and comfortable

Berry Compliant models are also available. Contact Customer Service at 800.347.1200 for more information and to purchase.

Non-Ballistic Riot Shields

2036H/2448H

PEACEKEEPER SHIELD

- Constructed of 4mm shatter-resistant polycarbonate
- Lightweight
- Ambidextrous

2036C/2448C

PEACEKEEPER II SHIELD

- Constructed of 4mm shatter-resistant polycarbonate
- Lightweight
- Ambidextrous if rotated 180°
- Comfort-molded cradle handle features high-density foam for comfort and strength



FRONT

Optional Police Decal Shown



COMFORT-MOLDED HANDLE

- 2036C: 20" x 36" (50.8cm x 91.4cm) Weight: 6 lbs.
- 2448C: 24" x 48" (60.9cm x 121.9cm) Weight: 6.8 lbs.



TRIANGLE HANDLE

- 2036H: 20" x 36" (50.8cm x 91.4cm) Weight: 6 lbs.
- 2448H: 24" x 48" (60.9cm x 121.9cm) Weight: 6.8 lbs.

2448E

CAPTURE SHIELD

- Capture Handle
- 2448E: 24" x 48" (60.9cm x 121.9cm)



Optional Sheriff Decal Shown

Non-Ballistic Riot Helmets

TR-1000**NON-BALLISTIC RIOT HELMET**

- Durable injection-molded polycarbonate shell
- High-retention strap system with flexible chin cup and quick connect release buckle
- High density foam neck protector for added comfort
- Combi-Fit Pad System provides sizing options for most head sizes
- Weight: 3.6 lbs (1.63 kg)

INTEGRATED NON-BALLISTIC RIOT FACE SHIELD

- Molded polycarbonate for clear viewing area
- Brim extends outward for extra clearance to accept gas masks
- Dual liquid barrier which channels liquid back away from lens and away from field of vision
- Meets NIJ standard 0104.02 Riot helmet requirements

**NEW****D4CC DELTA™ 4****CROWD CONTROL KIT**

- Ballistic protection (NIJ 0106.01 Tested, modified to address Type IIIA rounds & velocities)
- Warrior/ACH (brimless) style: Mid-cut
- Aramid ballistic material
- Integral rubber seal for liquid barrier at the helmet/shield interface
- Shield locks for stowed or deployed positions with release by hand
- Pivot and lock assembly transferable to the right or left of the shield for individual preference
- .150" lens thickness
- 8" lens length
- Nape Curtain (Constructed of Cordura® nylon and high-density foam with chemical-resistant plastic shock absorbent pads)





SPARE CUFF™



**8210-3
SPARE CUFF™**

- Standard single cuff for controlling both wrists/forearms and ankles
- 22" (55.88cm) when laid flat
- ½" (1.27cm) wide with beveled edges to reduce potential for subject injury
- Available in quantities of ten
- White 10 pack – 8210-3-10
- White 100 pack – 8210-3-10B
- Black 10 pack – 8210-3-2
- Black 100 pack – 8210-3-2B

DOUBLE CUFF™



**8220-3
DOUBLE CUFF™**

- The Double Cuff feature gives the officer greater control and the ability to stabilize the subject after one cuff is in place
- Two individual cuffs rather than the standard single cuff for controlling both wrists/forearms or ankles
- Standard length is 34" (86.36cm)
- Available in quantities of ten
- White 10 pack – 8220-3-10
- White 100 pack – 8220-3-10B
- Black 10 pack – 8220-3-2
- Black 100 pack – 8220-3-2B

CUTTERS



**8500-1
SAFETY CUTTER™**

- Lever action for smooth cutting of disposable plastic restraints
- Simple, fast, one-squeeze operation
- Pocket-sized for easy carry



**8210-0
COMPACT SPARE CUFF™**

- Compact version of Spare Cuff restraints
- User-friendly and easy to carry and store
- Ideal backup to steel handcuffs; can be carried in pocket, briefcase, glove compartment, etc.
- Available in quantities of three with an included Safety Cutter™

White 3 pack w/Safety Cutter – 8712
Black 3 pack w/Safety Cutter – 8713



**8220-2
COMPACT DOUBLE CUFF™**

- Compact version of Double Cuff restraints
- User-friendly and easy to carry and store
- Ideal backup to steel handcuffs; can be carried in pocket, briefcase, glove compartment, etc.
- Available in quantities of three with an included Safety Cutter™

White 3 pack w/Safety Cutter – 8710
Black 3 pack w/Safety Cutter – 8711

NEW



**8730
MOLLE DISPOSABLE CUFF HOLDER**

- Mount on a vest, belt or go bag with with MOLLE loop mounting system
- Deploy disposable cuffs with one hand
- Durable, lightweight polymer
- Holds (6) disposable cuffs



**8500-0
CUFF CUTTER**

- Can be used on any disposable restraint
- Pocket-sized for easy carry and storage
- Inexpensive and durable



TAKE CONTROL. AND KEEP IT.

Hiatt® handcuffs offer a variety of unique features designed to address the needs of today's law enforcement personnel. Our fast back-loading application allows an open cuff to be snapped back into place with a quick motion of the wrist and then reapplied without having to release the offender's hand. With 18 teeth, 3 independent retaining bars with 6 teeth on each, we make it extremely difficult to pick, while providing increased strength as the shackle engages the additional teeth. Finally, True Swing Technology ensures the swing arm is balanced and centered so it locks into the center of the shackle every time.



2010HD DOUBLE KEY HOLE CHAIN STYLE

Crafted from heavy-duty high carbon steel with reinforced steel swivels. Double key hole handcuffs make removing Hiatt handcuffs much easier. With key holes on both sides of the cuff, there is always one facing up for ease of access.



2010H

2010H / 2015H STANDARD CHAIN STYLE

Made from top quality steel, the chain style model features reinforced steel swivels for added strength and durability.

2010H – Nickel Plate Model
2015H – Black Finish Model



2075H

2050H / 2075H STANDARD HINGE STYLE

Crafted from high quality steel, the hinge style cuffs feature heavy-duty, solid hinges for reinforced holding power.

2050H – Nickel Plate Model
2075H – Black Finish Model



2054H

2054H / 2055H OVERSIZED HINGE STYLE

17% larger than the standard model, oversized hinge style cuffs are ideal for restraining larger subjects who have trouble placing their hands behind their backs.

2054H – Nickel Plate Model
2055H – Black Finish Model



2105H



UL-1-H

2103H / 2105H

RIGID STYLE NON-FOLDING

The Rigid handcuff provides a firm, comfortable grip that molds to the shape of your hand for added control and ease of application.

2103H – Nickel Plate Model
2105H – Black Finish Model

UL-1-H / UL-5-H

ULTIMATE - FOLDING STYLE

With heavy-duty construction this cuff features oversized rivet heads for added strength. Folds easily for storage.

UL-1-H – Nickel Plate Model
UL-5-H – Black Finish Model



8400-1

8400-2

8400

HANDCUFF KEYS

- Lightweight, oversized handcuff key
- Textured grip allows solid grasp of key, even in wet conditions
- 8400-1 features pocket clip
- 8400-2 features key ring

Metal Restraints



3103-H

3103-H
LIGHTWEIGHT STELOY CHAIN HANDCUFF

This chain style handcuff offers reinforced steel swivels for added strength and durability. The 3103-H Steloy is 40% lighter and 17% larger than standard cuffs. Constructed from a combination of aluminum and steel this lightweight model offers high strength without the extra weight.



3154-H

3154-H
OVERSIZED STELOY HINGE HANDCUFF

Crafted from a combination of steel and aluminum known as Steloy, this lightweight hinge style cuff features solid hinges for reinforced holding power. This lightweight hinged model cuff is 40% lighter and 17% larger than a standard hinge handcuff.

SAFARILAND TRAINING ACADEMY

MONADNOCK® DEFENSIVE TACTICS SYSTEM

(MDTS) INSTRUCTOR COURSE

This powerful two-day course shows you how to use your hands, elbows, knees and feet for protection against an attack, especially in close quarter battles (CQB). It relies heavily on practical hands-on applications and is intended for first responders who want instruction in how to use their personal weapons for self-defense and subject-control, for escort and handcuffing.

Contact the Safariland Training Group for details to take or host this course.

WWW.SAFARILAND.COM/TRAINING
800.347.1200 OPTION TRAINING

SEE INDEX ON PAGE 231 FOR INFORMATION ON CLASSES LISTED THROUGHOUT THIS CATALOG

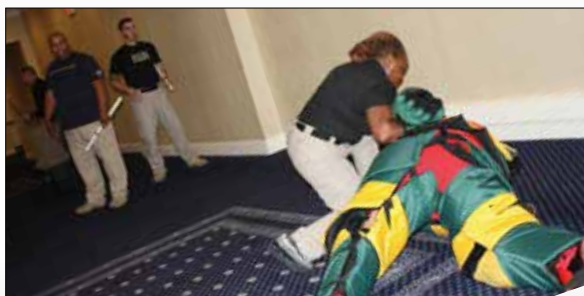

S U R V I V A B I L



See more at www.med-eng.com

ITY SYSTEMS



EOD PROTECTIVE EQUIPMENT & TOOLS - Med-Eng®
bomb suits and blast protective ensembles are trusted to save lives in over 100 countries and territories. The EOD® 10 sets a new gold standard for protection, mobility and operational capabilities. For tactical missions, the TAC 6 offers lighter weight and modular protection. The complete solutions we offer include personal blast sensors, Hook and Line (HAL®) and specialized EOD tools to maximize standoff.

SURVIVABIL



ITY SYSTEMS



ROBOTS, COOLING AND BLAST SEATS - The Avenger is a mid-sized bomb disposal robot with the operational capabilities of many larger sized robots. It is ideal for dealing with the increasing threat of Vehicle-Born IEDs and other challenging missions in urban centers. Med-Eng thermal management solutions include cooling systems for military vehicle occupants and their mission-critical electronics. These ruggedized systems can be customized for either heating or cooling, depending upon the mission. Med-Eng has fielded over 10,000 blast attenuation seats to protect military vehicle occupants from explosive events.



See the entire line at: forensicsource.com

FORENSICS



FORENSICS SOURCE



EVI-PAQ

nik

iDenticator



LIGHTNING POWDER® – The **LIGHTNING POWDER®** brand is the most extensive line of fingerprint and evidence marking products available.

EVI-PAQ® – Always evolving to meet the practical needs of forensics professionals in the field, **EVI PAQ®** products provide the solutions to marking, packaging and identifying crime scene evidence.

NIK® – The most accurate narcotics field identification, specimen and evidence collection kits available in the industry.

IDENTICATOR® – For the highest-quality fingerprinting products, agencies worldwide look to the **IDENTICATOR®** brand. Combining non-smearing with instantly permanent qualities in both ink and inkless systems.

A R



To request a quote for a custom armor system visit: safariland.com/armorsystems

MOR SYSTEMS



From Ballistic Resistant Enclosure® (BRE®) units and Armored Fighting Positions (AFP) to lightweight composite armor for sea, air and land vehicles, PROTECH® offers a complete range of advanced product solutions for government facilities, military installations, private and public corporations, and original equipment manufacturers (OEM).

Armor Systems

GUARD BOOTHS

Standard and customized guard booths are available in sizes ranging from 4' x 4' to 10' x 20' or greater. Size, layout, and configuration variants offer solutions for each client's specific requirements.

- All levels of ballistic protection featuring ARMOR-LOK™
- Blast and fragmentation protection
- Multi-layer "no-spall" or "low-spall" transparent armor
- Ballistic- and blast-resistant gunports and window systems
- All-welded construction
- Chemical, biological, radiological and nuclear (CBRN) filtration systems
- Fully engineered HVAC systems
- High-performance coatings
- Electrical systems to meet any requirement
- Customized interiors
- Standard units or custom-designed to meet specifications
- Restrooms available
- Conduit-penetration protection
- Exterior lighting systems



Our exclusive ARMOR-LOK™ designs offer seamless 360° protection to all areas of each structure to include windows, doors and gunport systems with zero vulnerability

GUARD TOWERS

PROTECH's fully engineered bullet-resistant & (optional) blast-resistant guard towers are turn-key solutions for perimeter security applications at nuclear facilities, military installations, border crossings, chemical/petroleum plants, correctional facilities, and other industrial locations.

- Offering the same features as our BRE® units, these units are fixed on pedestals and tower systems for elevated security
- All levels of ballistic protection featuring ARMOR-LOK™
- Fully engineered, blast- and hurricane-rated tower designs
- 360° seamless protection
- Constructed with structural steel components
- Galvanized stair systems
- Prefabricated towers
- Optional catwalks and shooting stations
- Pre-cast foundations for ease of installation



CUSTOM ARMOR

Our complete manufacturing and fabrication capabilities enable us to work with end users, original equipment manufacturers (OEM), or prime contractors to design and develop advanced armor systems for virtually any application. From vehicle platforms to structural or shelter systems, from personnel to critical infrastructure protection, we are positioned well to meet a broad range of ballistic and blast requirements.

TRAILER ARMOR KITS

- With our in-house engineering PROTECH® offers the ability to rapidly produce lightweight, customized armor kits and components for unique applications

STEEL ARMOR COMPONENTS AND ASSEMBLIES

- Offering full MIG and TIG welded steel and/or aluminum armor assemblies, our technicians are AWS Certified for unlimited plate thickness
- Steels include: MIL-A-46177, MIL-A-46100, MIL-A-12560, AR500

COMPOSITE ARMOR SOLUTIONS

- From flat panel construction to unique 3-dimensional parts, our fabrication capabilities enable us to produce tooling in-house for most applications



Armor Systems

ARMOR FIGHTING POSITIONS

- Ballistic and fragmentation protection
- ARMOR-LOK™ design
- Lifting lugs for ease of installation
- Durable, textured finish with high-performance coatings
- Gunports

APPLICATIONS INCLUDE:

- Vital asset protection
- Check point security
- Perimeter protection
- Fixed fighting locations
- Supplemental guard house security
- Replacement of sandbags and concrete structures



The PROTECH® engineering and design team is ready to address all of your ballistic and security concerns. We will develop the system that works for you.

BOAT ARMOR

- Mission-specific modular kits to full OEM integration, the PROTECH® line of maritime armor offers systems for all types of protection requirements
- Broad portfolio of lightweight composite systems for ball and armor-piercing (AP) threats, addressing most small arms protection requirements
- Polyethylene systems affording least-weight penalty, which are buoyant and unaffected by freshwater, saltwater and UV rays
- Superior multi-hit, ballistic performance solutions
- Exterior coatings, which enable protection against the harshest of environments, for long-term serviceability



AIRCRAFT ARMOR

- PROTECH® Armor Systems line of land and air products include a wide array of ballistic, blast and fragmentation solutions
- Ballistic panels are easily installed and removed by front-line personnel. In most cases, no special tooling is required and armor systems can be easily transferred from one aircraft to another
- The availability of replacement panels eliminates the full replacement of the kit, thus reducing cost and aircraft downtime
- Polyurea protective coatings afford optimal durability, performance and slip resistance
- Excellent resistance to, and protection from, a variety of environmental and chemical situations



TRAINING



NG ACADEMY



SAFARILAND[™]
TRAINING ACADEMY



The Safariland Training Academy provides the most up-to-date and comprehensive training programs available anywhere in the world. Our newly enhanced and expanded programs build individual skills and provide solutions for criminal justice, military, corrections and privately licensed security personnel. What sets us apart is our team of highly-experienced instructors. Their real-world experiences in law enforcement provide practical and proven tactics to enhance the performance of your team.

Training Academy

BALLISTIC SHIELD INSTRUCTOR COURSE

This intensive three-day course provides instructors with the techniques and skills required to train their department's personnel in operating a ballistic shield. Students will learn drills, shooting techniques and tactics for the ballistic shield officer, while being required to make presentations, supervise range drills and develop course(s) of fire.



COUNTER AMBUSH TACTICS FOR OFFICER SURVIVAL OPERATOR COURSE

This training program consists of one day of classroom lecture and one day of practical exercises and scenario training, based on the real-world incidents that have injured and killed an ever increasing number of officers. Our instructors have extensive experience in the world of law enforcement, violent attacks on police officers and tactical responses to neutralize the threat.



CROWD MANAGEMENT AND MOBILE FIELD FORCE INSTRUCTOR COURSE

The skills presented in this class have been proven on the streets of America and internationally as part of a Department of Justice training program. Through this course, the line officer and supervisors learn how to maintain order when faced with gatherings from spontaneous acts of civil disobedience to large-scale riots. Students are very active during this five-day course as they progress through the proper use of tactics, equipment and less lethal munitions. Join the professionals who have prepared themselves for the threats found in the streets and the courtroom while they protect the rights of our citizens.



DEFENSIVE TACTICS INSTRUCTOR COURSE

This 5-day, highly dynamic course is like no other because it provides useful defensive and countermeasure skills in all three zones of defense, especially for close quarter battles (CQB) and effecting the arrest. It relies heavily on practical, hands-on applications and is intended for those who want instruction in the proper uses of both soft and hard empty-hand techniques, weapons retention, and use of straight batons (expandable or rigid) for self-defense. The course also provides subject-control for escort/takedown and handcuffing, handcuffing techniques for passive and active resistance individuals with chain and hinge cuffs, along with proper usage and application of aerosol OC.



Contact the Safariland Training Academy for details to take or host these courses.

**WWW.SAFARILAND.COM/TRAINING
800.347.1200 OPTION TRAINING**

LOW-LIGHT BUILDING SEARCHES INSTRUCTOR COURSE

This course is designed to give first-responding officers the knowledge, tools and tactics necessary to not only survive a low-light encounter during a building search, but to WIN it. The curriculum focuses on the different options available while working in low-light or no-light conditions.



PATROL RIFLE INSTRUCTOR COURSE

For most agencies, the patrol rifle is the long arm of choice and using it properly is vital. In many training environments, the emphasis is put on taking all the time needed, and pulling the trigger repeatedly. This two-day course will stress the need for speed relative to first shot readiness, and then shift to first shot effectiveness. The goal is to teach students to deploy with speed and to fire with precision.



RIOT SHIELD AND RIOT BATON INSTRUCTOR COURSE

This is a two-day, highly dynamic instructor level course that teaches officers proper usage of the Monadnock® riot shields and batons in Crowd Management/Mobile Field Force situations. Course content draws from our time-tested Monadnock Expandable Baton, Monadnock Defensive Tactics System and PROTECH® Tactical Shield Instructor programs. It relies heavily on tactics to protect officers from thrown objects and close-in crowds while utilizing the shield, baton protection for self-defense and subject control, as well as small unit tactics for control and arrest of subjects.



TACTICAL BREACHING INSTRUCTOR COURSE

This three-day, instructor-level course provides students with the necessary tools and tactics to deploy an objective and make forced entry through the means of a manual ram and/or pry bar, shotgun breaching rounds and flash-bang breaching.

ALSO AVAILABLE:

- Active Shooter Operator
- Barricade Solutions Operator
- Combat Medicine for Law Enforcement Operator
- Controlled Structure Searching Operator
- Emergency Response to an Armed Intruder
- Female Officer Survival Operator
- High-Risk Warrant Service Operator
- Hostage Rescue Operator
- Shoot-House Instructor
- Sniper Development Workshop
- Startle Response to an Ambush Operator



BODY ARMOR

CONCEALABLE ARMOR

F1 Ultra Concealable Carrier 12
 Hardwire® Ballistic Panel 7
 M1 Carrier 11
 Matrix® Ballistic Panel 8
 P1 Carrier 11
 Prism™ Armor Panels 9
 Summit™ Ballistic Panel 8
 SX™ Ballistic Panel 10
 U1 Uniform 14
 U1 Pocket 14
 V1 Clean 13
 V1 EMS 15
 V1 Firearms Instructor Pocket 15
 V1 Firearms Instructor Webless 15
 V1 Hi-Vis Clean 15
 V1 Hi-Vis Webless 15
 V1 Pocket 14
 V1 Webless 13
 Xtreme® Ballistic Panel 10

PROTECH®

2113 31
 2113MC 29
 2014 31
 2014MC 30
 2120 31
 2120-5 30
 9812-R1 30
 All Purpose Vest 24
 Assault 1, 2 and 3 Type III 42
 Ballistic Barrier Blanket Type IIIA 41
 Ballistic Face Shields 37
 Bark-9™ Hi-Speed Canine Armor System 26
 Blue Force Gear® Technologies 26
 Body Bunker® Series 39
 Defender 40
 Delta™ 4 35
 Delta™ 5 34
 Delta™ 6 35
 Delta™ X 34
 DK6-H.150 Non-Ballistic Face Shields 37
 DK7-X.250AF-R Non-Ballistic Face Shields 37
 DT-206C Type III Plate 30
 DT-306C Type III Plate 30
 DT-306P Type III Plate 30
 DT-106E Type III Plate 29
 DT-106P Type III Plate 37
 Entry Shield Series Type IIIA 40
 Fast Attack Vest 22
 Fragmentation Blanket 41
 First Responder Series 41
 FirstSpear® Technologies 26
 FoxFury® HHC Tactical Light 36
 FoxFury® Taker B10 43
 FoxFury® Taker B30 43
 FoxFury® Taker B50 Shield Light 43
 Hardwire Ballistic Technologies 26
 Hardwire Plate Series 25
 Hardwire Ballistic Panels 33
 Hi-Viz Shield 38
 HW-ICW-III 32
 HW-ICW-III-HBA 29
 HW-LWP-III 29
 IMPAC™ Plate Line 33
 Intruder™ Series Type IIIA 40
 Matrix® Ballistic Panel 25
 Mighty Mite 40
 NATO SS Ballistic Shield 42
 PASGT 35

Patroller 41
 Patroller FR 41
 Phoenix IV™ 43
 Portal Ladder™ 28
 Pouch Backers Helium Whisper® 35
 R2S Ratchet System 36
 Shield Support Hook 42
 Shift 360™ 19
 Tactical Soft Accessories 34
 Special Threat Plates 39
 Strike Shield 41
 Summit™ Ballistic Panel 25
 SX™ Ballistic Panel 25
 TAC™ PH 21
 TAC™ PR 20
 Team Wendy® Suspension Systems 36
 Titan™ Assault Vest 23
 Traditional Pouch Backers 27
 TSI Shield Series 39
 Weapons Trunk Box 28
 X Series Lightweight Shields 38
 X-CAL™ Plate Series 32
 Xtreme® Series Ballistic Panels 25

COMMUNICATIONS

SAFARILAND/TCI®

10-2 Receive Only Kit 53
 Alpha Push-To-Talk (APTT) 49
 CIPS Kit 53
 Gas Mask Adaptor (GMA) 49
 Helmet Mounting Solutions 48
 Liberator® Flashpoint™ 54
 Liberator® Spark™ 55
 Liberator® Overwatch™ 55
 Liberator® IV Single Communications Headset 46
 Liberator® V Dual Communications Headset 47
 Liberator® V with R.A.C.E. 48
 Liberator® V Tactical Wireless Module 49
 Liberator® HP Hearing Protection 52
 M.A.S.T. Modular Antenna System Tactical 50
 Mobile Force Field (MFF) Kit 49
 SAS II Special Air Service Low-Vis 51
 TABC III Dual Communications 52
 TECS Modular Earpiece 51
 TTMK III™ Tactical Throat Microphone 51
 Two-Wire Patrol Kit 53

DUTY GEAR

SAFARILAND®

2 Hi-Ride Level I Retention™ Duty 63
 002 Cup Challenge Competition Holster 101
 014 Open Class Competition Holster 101
 014 Adapter Kit 102
 17 IWB Holster 95
 17T IWB Holster with J-Hook 95
 18 IWB Holster 94
 25 Inside-the-Pocket Holster 94
 27 Inside-the-Pants Concealment Holster 101
 030 Buckleless™ Competition Underbelt – 1.5" (38mm) 102
 031 D-Ring Belt 1.5" (38mm) 68
 032 ELS Competition Belt 1.75" (45mm) 91, 110
 33 Surgical Glove Holder 72
 34 OC Holder 86
 35 Baton Holder 70
 36 OC Holder 86
 37-8 Open Top Impact Round Holder 72, 80
 37 Open Top Mace®/OC Spray Holder 72
 38-8 Impact Round Case, Top Flap 72
 38 Mace®/OC Holder 72
 40 Distraction Device® Holder 80
 51 Garrison With Square Buckle 1.75" (45mm) 68

62 Belt Keeper 71
 63 Slotted Belt Keeper 71
 65 Belt Keeper 71
 67/67S Baton Ring 71
 71 Injection Molded Mag Pouch 103
 72 Double Magazine and Cuff Pouch 70
 73 Open-Top Double Magazine Pouch 70
 75 Open Top Double Magazine Pouch 70
 76 Single Magazine Pouch 70, 80
 77 Double Magazine Pouch 76
 78 Slimline Double Magazine Pouch 69, 80
 070 SSIII Level III with Mid-Ride UBL 60
 075-2 Hearing Protection Holder 99
 079 Open Top Double Magazine Pouch – Snap 97
 79 Slimline Open Top Double Magazine Pouch 69
 080-12 Shotgun Shell Holder 79, 104
 81 Open Top Single Magazine – Snap 97
 085 Shotgun Shell Holder 104
 086 Shotgun Shell Holder 104
 87/87V Sam Browne Belt 2.25" (58mm) 68
 090 Open Top Handcuff Case 72
 90/90H Handcuff Case 72
 94/94P Buckleless™ Belt 2.25" (58mm) 68
 99/999 Buckleless™ Reversible Belt 1.5" (38mm) 68
 123 Magazine Pouch – Horizontal 97
 135 Baton Holder 76
 146/146V Border Patrol With Buckle 2.25" (58mm) 68
 168 Key Ring 71
 169S Key Ring 71
 170 Silent Key Holder 71
 190/190H Handcuff Case 78
 200 Top Gun Level I with Mid-Ride UBL 63
 290/290H Double Handcuff Case 78
 306 Open Top Mini-Flashlight Holder 70
 307 Light/EDW Cartridge Holder 70
 308 Handheld Flashlight Holder 70
 332 Range Belt 1.5" (38mm) 102
 334 Rigid Competition Belt 1.5" (38mm) 102
 340 Double Speedloader Holder 73
 371 Single Speedloader Holder 73
 521-CAP EDW Cartridge Accessory Plate 64
 537 GLS™ Open Top Concealment Belt Slide 90
 547 PRD™ Open Top Concealment Belt Slide Holster 92
 557 Open Top Concealment Belt Slide Holster 92
 565BL Hi-Ride Concealment Belt Loop 72
 566 Hi-Ride Belt Slide 93
 566BL Belt Loop 72
 567BL Belt Loop 1.5" – 2.25" 72
 567 Custom Fit Belt Loop Holster 93
 568 Custom Fit Paddle & Belt Loop Combo Holster 93
 568BL Paddle – Up to 1.75" 66
 569 Belt Clip 93
 571BL Micro Paddle 72
 571 Pro-Fit Concealment with Micro Paddle 73
 572 Open Top Double Magazine Pouch – Paddle 97
 573 Magazine Holder & Handcuff Pouch 97
 574 Magazine Holder and Light Pouch – Paddle 97
 575 GLS™ Pro-Fit™ IWB 95
 576 Hi-ride Belt Slide 91
 578 Pro-Fit™ Concealment Paddle & Belt Loop Combo 91
 590 Magazine Holder and Handcuff Pouch 103
 654 Slotted Belt Keeper 71
 655 Heavy Duty Belt Keeper 71
 690 Handcuff Strap 72
 692S Baton Ring with Snap 72
 705 with Low-Ride UBL 60
 730 Heavy-Duty Flashlight Ring 72
 745BL Belt Clip 72
 761 Adjustable Radio Holder 73
 762 Radio Holder with Swivel 73
 763 Universal Radio Holder – Portable 73

764 Recorder Case	72	6355 ALS® Tactical Holster with Quick-Release Leg Strap ..	77	Safariland Range Kit	98
766 Radio Holder	73	6360 ALS®/SLS III with Mid-Ride UBL	61	TMA Tactical MOLLE Adapter	82
768 Compact Spare Cuff™ Holder	72	6362 ALS®/SLS III with Hi-Ride UBL	61	TS-2900 Safariland® Long-Sleeve Performance Shirt	105
771 Open Front Magazine Pouch	103	6365 ALS®/SLS III with Low-Ride UBL	61	TS-3200 Safariland® Performance T-Shirt	105
773 Open Top Single Magazine Pouch	103	6367 ALS®/SLS Belt Loop Holster	90	TS-6600/TS-6610 Performance Polo Shirt	105
774 Rifle Magazine Pouch	86, 82, 103	6376 Hi-Ride Concealment Paddle & Belt Loop Combo	88	TS-9250/9255 Safariland® Hat	105
775 Slimline Open Top Triple Magazine Pouch	69	6378 ALS® Concealment Paddle & Belt Loop Combo	88	T-SPACER-KIT	71
776 Competition Magnetic Magazine Holder	102	6378USN ALS® Low Signature Holster	79	Universal Belt Loop (UBL) Styles	71
777 Slimline Triple Magazine Pouch	69	6379 Belt Clip	88	USPSA Kit	110
872 Contoured Belt 2.25" (58mm)	68	6384 ALS® OMV Tactical Holster	78	Vertical Universal Belt Loop	65
875 Sam Browne Stitched Edge 2.25" (58mm)	68	6385 ALS® OMV Tactical Holster	79		
942 Contoured Buckleless™ Belt	68	6390 ALS® Level I with Mid-Ride UBL	63	BIANCHI®	
992 Reversible SafariLaminate™ Belt 1.5" (38mm)	68	6392 with Hi-Ride UBL	63	1L Lawman™	131
1051 ALS® Shoulder Holster	96	6395 with Low-Ride UBL	63	3S Pistol Pocket®	127
2005 with Low-Ride UBL	63	6520 SLS EDW Holster with Clip	64	5BHL Thumbsnap	131
2955 with Low-Ride UBL	62	7004 7TS™ SLS® Tactical Holster	75	5 Black Widow™	126
4320 Padded Belt Liner	68	7005 7TS™ SLS® Tactical Holster	75	6D ATB™ Waistband	127
4325 Nylon Buckleless™ Reversible Belt 1.5" (38mm)	68	7053 7TS™ ALS® Lightweight Shoulder Holster	96	6 Waistband	127
4330 Padded Underbelt	68	7280 7TS™ SLS Mid-Ride Level II Retention™	62	6T Waistband Tuckable	127
4331 MOLLE Battle Belt	80	7282 Hi-Ride UBL	62	7 Shadow® II	124
4333/4333WP Low Profile Battle Belt	80	7285 Low-Ride UBL	62	19L Thumbsnap	131
4552 Dual Rifle Case	83	7304 7TS™ ALS® Tactical Holster	75	20A Open Top Magazine Pouch	130
4553 Premium Dual Handgun Case	83	7305 7TS™ ALS® Tactical Holster	75	20C Double Magazine Pouch	121
4555 Shooters' Range Bag	103	7350 Badge Holder	97	21 Open Top Magazine Pouch	130
4559 Shooters' Range Backpack	103	7352 Badge Holder	97	29 Triple Threat™ Magazine Pouch	121
4566 Enhanced 3-Gun Bag	83, 103	7354 7TS™ ALS® Tactical Holster	76	31 Key Flap	121
5196 Hi-Ride Belt Slide	98	7355 7TS™ ALS® Tactical Holster	76	31C Silent Key Holder	121
5197 Range Series Open Top Mid Ride Holster	92, 101	7360 7TS™ ALS®/SLS Hi-Ride Level III Retention™	60	32A Expandable Baton Holder	121
5198 Open Top Concealment Paddle & Belt Loop Combo ..	92	7362 Hi-Ride UBL	60	32P Baton Holder	121
5199 Range Series Holster with Belt Clip	92	7365 7TS™ ALS®/SLS Low-Ride Level III Retention™	60	33 Belt Keeper	121
6000 SLS Hood Guard	66	7367 7TS™ ALS®/SLS Concealment Belt Slide Holster	90	35P Handcuff Case	121
6001 SLS Sentry	66	7371 Micro Paddle	89	36A Mace®/OC Spray Pouch	121
6002 SLS Sentry & Hood Guard	66	7376 Hi-Ride Belt Slide	89	37BL D-Cell Light Holder	121
6004-6 Standard Double Leg Shroud	80	7377 7TS™ ALS® Concealment Belt Slide Holster	89	37M Mini Light Holder	121
6004-10 Single Strap Leg Shroud	80	7378 7TS™ ALS® Concealment Paddle	89	37S Compact Light Holder	121
6004-11 Leg Strap Only	81	7379 Belt Clip	89	45 Mag/Cuff Paddle	130
6004-24 MLS Accessory Fork on Small MOLLE Plate	86	7390 7TS™ ALS® Level I Retention™	63	55L Lightnin'®	125
6004-27 Drop Flex Adapter on Single Leg Shroud	81	7392 with Hi-Ride UBL	63	56 Serpent™	124
6004-DFA Drop Flex Adapter	67	7395 with Low-Ride UBL	63	57 Remedy™	124
6004 SLS Tactical Holster	77	7520 7TS™ SLS EDW Holster w/Clip	64	58 P.I.™	124
6004-UFA Universal Flex Adapter	67	CD-2 Speedloader Holder	73	75 Venom™	126
6004UFA Universal Flex Adapter	81	CD-AUTO Auto Magazine Holder	103	77 Piranha™	126
6004USN Low Signature SLS Tactical Holster	77	COMP I / II / III Speedloader	104	82 CarryLok™	126
6005-6 Standard Double Leg Shroud	80	Competition Rigs	108	100 Professional™	127
6005-10 Single Strap Leg Shroud with Quick-Release	81	Customized-Kit	65	101 Foldaway™	125
6005-12 Shotgun Speedloader Holder	104	DVD Training DVDs	105	105 Minimalist™ With Slots	125
6005-23 MLS Accessory Fork on Quick Release Harness ..	87	Electronic Hearing Protection	104	111 Cyclone™	131
6005-23 MLS Accessory Forks on Quick-Release Strap ..	82	ELS 34 & 35	84	126 Assent™	122
6005 SLS Tactical Holster with Quick-Release Leg Strap ..	83	ELS-KIT 1	93	131 Confidential™	122
6005VE Quick-Release Buckle	81	Hardware Kit	105	135 Suppression™ IWB	123
6006 ALS® Guard	66	HDA-Kit	65	140 Reveal™	122
6007 ALS® Hood Guard	66	HK-11 Hide-a Keyper™	77	145 Subdue™ IWB	123
6008 Hood Guard & ALS® Guard	66	HRA Hi-Ride Adaptor	65	150 Negotiator™ Ankle Holster	128
6009-110 Single Strap Leg Shroud with D-Ring	81	In-Ear Impulse Hearing Protection	99	152 Pocket Piece™	128
6009-11 D-Ring Strap	81	Liberator® HP	99	155 Subversion™ IWB	123
6009-23 MLS Accessory Fork on D-Ring	88, 87	Military Kit ALS®	79	580 Speed Strips™	130
6009VE D-Ring Strap	81	MLS 16	84	4025 Inside the Pocket Holster	128
6034 SLS Military Tactical Holster	78	OVAL SPACER-KIT	71	4065 IWB Magazine Holder	130
6035 SLS Military Tactical Holster	78	P2201 Converts 2.25" UBL To a 2" Belt Slot	71	4452 Range Portfolio™	130
6070UBL 2" or 2.25"	65	QLS 19 & 22	85	4585 Prevader™	115
6072UBL Hi-Ride UBL	65	QUICK-KIT 1	87	7000 AccuMold® Sporting Holster	131
6075UBL 2" or 2.25"	65	QUICK-KIT 2	87	7001 AccuMold® Thumbsnap	131
6075UBL-PAD	65	QUICK-KIT 3	87	7105 Cruiser™ Duty Holster	110
6280 SLS Level II Retention™ with Mid-Ride UBL	62	QUICK-KIT 4	87	7115 Vanguard™ Duty Holster	110
6281HDA	65	RLS™ Rapid Light System	100	7120 Defender® Duty Holster	110
6282 with Hi-Ride UBL	62	RLSM Mount for Duty Belt	100	7200 Duty Belt 2.25" (58mm)	111
6285 SLS Level II with Low-Ride UBL	62	RLSR RLS™ Reduction Sleeve	100	7201 Training, Hook and Loop Belt 1.75" (45mm)	131
6287 SLS EDW Belt Loop	64, 90	RRL Rogers' Rail Lite	100	7202 Nylon Training Belt 1.75" (45mm)	112
6304 ALS®/SLS Tactical Holster	76	SAF-CUP-2 Coffee Tumbler	105	7203 Nylon Duty Belt - Hook 2.25" (58mm)	111
6305 ALS®/SLS Tactical Holster	76	SAF-CUP-MUG Coffee Mug	105	7210 Duty Belt 2" (50mm)	111
6354 ALS® Tactical Holster	77	SAF Decal Safariland Decal	105	7215 Nylon Web Belt w/ Drag Loop (2")	111

7216 Nylon Web Belt w/ Drag Loop (2.25")..... 111
 7220 Duty Belt 2" (50mm)..... 111
 7221 Ballistic Belt 2" (50mm)..... 112
 7225 ErgoTek™ Duty Belt 2.25" (58mm)..... 111
 7235 Duty Belt System 2.25" (58mm)..... 111
 7300 Covered Handcuff Case..... 114
 7301 Speedloader Pouch..... 113
 7302 Double Magazine Pouch..... 113
 7303 Single Magazine Pouch..... 113
 7307 Mace®/OC Spray Holder..... 114
 7308 Open Top Mace®/OC Holder..... 114
 7310 Mini-Light Holder..... 114
 7311 Compact Light Holder..... 114
 7312 Expandable Baton Holder..... 114
 7314/7314S Universal Radio Holder..... 115
 7315 Pager/Glove Holder..... 115
 7316 Silent Key Holder..... 115
 7317 Double Handcuff Case..... 114
 7318 Ultimate Hinge Handcuff Case..... 114
 7320 Triple Threat™ II Double Magazine Pouch..... 113
 7323 Adjustable Radio Holder..... 115
 7324/7324S Slimline Radio Holder..... 115
 7326 Compact Light Holder..... 114
 7328 Flat Glove Holder..... 115
 7334 Open Top Handcuff Case..... 114
 7335 EDW Single Pouch..... 113
 7336 EDW Double Pouch..... 113
 7404 Baton Ring..... 115
 7405 Key Holder..... 115
 7405K Key Holder Belt Keeper..... 115
 7406 Belt Keeper..... 115
 7409 Flashlight Ring..... 115
 7409K Flashlight Ring Belt Keeper..... 115
 7900 Covered Handcuff Case..... 116
 7902 Double Magazine Pouch..... 116
 7903 Single Magazine/Knife Pouch..... 116
 7904 Side-Handle Baton Holder..... 117
 7906 Belt Keeper..... 117
 7907 Mace®/OC Spray Holder..... 117
 7908 Open Top Mace®/OC Spray Holder..... 117
 7909 D-Cell Light Holder..... 117
 7911 Covered Compact Light Holder..... 117
 7912 Expandable Baton Holder..... 117
 7914S Universal Radio Holder..... 117
 7915 Pager/Glove Holder..... 116
 7916 Silent Key Holder..... 117
 7917 Double Handcuff Case..... 116
 7918 Ultimate Hinge Handcuff Case..... 116
 7920 Defender® II Duty Holster..... 110
 7922 Triple Threat™ II Double Magazine Pouch..... 116
 7923 Adjustable Radio Holder..... 117
 7926 Compact Light Holder..... 117
 7928 Flat Glove Holder..... 117
 7934 Open Top Handcuff Case..... 116
 7935 EDW Single Pouch..... 116
 7936 EDW Double Pouch..... 116
 7950 Duty Belt 2.25" (58mm)..... 111
 7955 ErgoTek™ Duty Belt 2.25" (58mm)..... 111
 7960 Sam Browne Belt 2.25" (58mm)..... 111
 7965 ErgoTek™ Sam Browne Belt 2.25" (58mm)..... 111
 7970 Buckleless™ Duty Belt 2.25" (58mm)..... 111
 7980 Duty Belt 2" (50mm)..... 111
 8000 Covered Handcuff Case..... 119
 8001 Single Handcuff Case with Key Slot..... 119
 8002 Double Magazine Pouch..... 118
 8003 Single Magazine Pouch..... 118
 8006 Belt Keeper..... 120
 8006I Slide-On Belt Keeper..... 120
 8007 Mace®/OC Spray Holder..... 120
 8008 Open Top Mace®/OC Spray Holder..... 120

8009 Flashlight Ring..... 120
 8010 Mini-Light Holder..... 119
 8011 Compact Light Holder..... 119
 8012 Expandable Baton Holder..... 120
 8013S Expandable Baton Holder with Swivel..... 120
 8014/8014S Universal Radio Holder..... 120
 8015 Pager/Glove Holder..... 118
 8016 Silent Key Holder..... 118
 8017 Double Handcuff Case..... 119
 8018 Ultimate Hinge Handcuff Case..... 119
 8020 Triple Threat™ II Double Magazine Pouch..... 118
 8026 Compact Light Holder..... 119
 8028 Flat Glove Holder..... 120
 8034 Open Top Handcuff Case..... 119
 8035 EDW Single Pouch..... 118
 8036 EDW Double Pouch..... 118
 8038S Rigid Handcuff Case..... 119
 8100 Duty Belt 2" (50mm)..... 112
 8105 Liner Belt – Hook 1.5" (38mm)..... 112
 8106 Liner Belt – Loop 1.5" (38mm)..... 112
 8110 Duty Belt with Hook Lining 2" (50mm)..... 112
 8300 Nylon Belt System 2" (50mm)..... 112
 ARS Radio Swivel Attachment..... 115
 B2 Sam Browne Belt 2.25" (58mm)..... 112
 B4 Ranger Belt 1.75" (45mm)..... 130
 B8G Garrison Belt 1.75" (45mm)..... 120
 B9 Fancy Stitched Belt 1.75" (45mm)..... 130
 B12 Sport Stitched Belt 1.5" (38mm)..... 130
 B21 Contour Belt 1.75" (45mm)..... 130
 B28 Professional™ Belt 1.5" (38mm)..... 130
 B29 Professional™ Belt 1.25" (32mm)..... 130
 M12 Universal Military Holster..... 132
 M13 Chest Harness..... 133
 M1020 Web Pistol Belt..... 133
 M1025 Military Magazine Pouch..... 133
 M1030 Military Magazine Pouch..... 133
 M1415 Thumb Snap System..... 133
 M1425 Thumb Snap System..... 133
 M1430 Universal Military Adapter..... 133
 T6500 Tac Holster LT..... 132
 T6505 Tac Holster..... 132
 T6510 Modular Accessory Panel..... 133
 T6521 Double AR15 Pouch..... 133
 UM84I Universal Military Holster..... 132
 UM84II Universal Military Holster..... 132
 UM84R Universal Military Holster..... 132
 UM84 Universal Military Holster..... 132
 UM92I/UM92II Universal Military Holster..... 132
 X15 #X15® Shoulder Holster..... 129
 X16A Double Magazine Pouch..... 129
 X16 Agent™..... 129
 X16P Offside Accessory Panel..... 129
 X16R Speedloader Panel..... 129
 X16T Tie-Down Accessory..... 129

BIANCHI COWBOY

California Outlaw™..... 137
 Cattle Driver™..... 135
 Clearwater™..... 136
 Getaway™..... 134
 Hondo™..... 136
 Hondito™ Belt..... 136
 Limited Edition Kenda Lenseigne Series Rigs..... 135
 Long Gun Holder..... 135
 Long Gun Scabbard..... 135
 Kendra Lenseigne Series Rigs..... 134
 Path Blazer™..... 134
 Smokechaser™..... 134
 Texas Outlaw™..... 137
 Wild Clearwater™..... 136
 Wild Clearwater™ Dual Magazine Pouch..... 136

PROTECTIVE GEAR

HATCH®

A6 Munitions Bag..... 150
 BNG190 Flight Glove..... 146
 CT250 CoolTac™ Police Duty..... 143
 DNR100 DayNite™ Reflective..... 148
 E4 ExoTech® Carry Bag..... 151
 FM2000 Friskmaster™ with Honeywell Spectra®..... 145
 G3 Giant SWAT Bag..... 151
 HLG250 ShearStop™ Half-Finger Cycle..... 143
 HMG100 Hatch® Mechanic's..... 146
 KP250 Centurion™ Knee Pads..... 149
 KSG500 Shooting Glove..... 146
 LR25 Reactor™..... 146
 M2 Mission Specific Gear Bag..... 151
 NS430L Winter Specialist® Shooting/Duty..... 144
 NS430 Specialist® All-Weather Neoprene Shooting/Duty..... 142
 PPG2 ArmorTip™ Puncture Protective Glove..... 144
 RFK300 Resister™..... 145
 SG20P Dura-Thin™ Police Search Duty..... 142
 SGK100 Street Guard™..... 145
 SGX11 Street Guard™..... 145
 SOG-600 Operator™ Tactical..... 146
 SP100 Defender™ II with Steel Shot..... 147
 S7 Sling Pack..... 150
 TSK323 Task Light Leather..... 141
 TSK324 Task Medium..... 141
 TSK325 Task Medium..... 141
 TSK326 Task Heavy Knuckle..... 141
 TSK327 Task Heavy SOGL..... 147
 TSK328C Task Heavy SOGL LT..... 147
 TSK329 Task Heavy SOGHK..... 147
 TSK330C Task Heavy SOGHK LT..... 147
 TSK331 Task Hi Vis..... 148
 WG1000S White Cotton Parade..... 148
 WPG100 Winter Patrol..... 144
 XTAK100/200/300/400/500 XTAK™ Knee Pads..... 149
 XTAK150/250/350/450/550 XTAK™ Elbow Pads..... 149

FIREARMS ACCESSORIES

BREAK FREE®

CLP-2 4 oz. (113 g) CLP® Aerosol..... 161
 CLP-4 4 oz. (113 g) CLP® Aerosol..... 161
 CLP-5 1-Pint (500 ml) CLP® with Trigger Sprayer..... 161
 CLP-7 1 U.S. Gallon (3.8 l) CLP®..... 161
 CLP-8 1-Quart (1 l) CLP® with Trigger Sprayer..... 161
 CLP-8 2 oz. Pump Spray..... 161
 CLP-12 12 oz. (340 g) CLP® Aerosol..... 161
 CLP-16 0.68 oz. (19 ml) CLP® Squeeze Bottle..... 161
 CLP-20 2 oz. (59 ml) CLP® Bottle With Dropper Tip..... 161
 CLP-PS CLP® Precision Shooter®..... 161
 CO-4 4 oz. (120 ml) Collector®..... 162
 DP-2 Collector® Kit..... 161
 GC-16 12 oz. (340 g) Powder Blast™..... 162
 LP-4 4 fl. oz. (120 ml) Lubricant Preservative..... 162
 LP-PS Precision Shooter®..... 162

KLEENBORE®

BL304 Bore Inspector®..... 160
 CF9 .45/9mm Chamber Flag..... 160
 CF22 .22 Caliber Chamber Flag..... 160
 Chamber Flag..... 160
 Classic Cleaning Kits..... 154
 Classic One-Piece Rods..... 156
 Cotton Patches & Cloths..... 159
 Field Pack Kits..... 155
 Multi-Sectional Cleaning Rods..... 156
 Phosphor Bronze Brushes..... 158
 Pocket Handgun Kits..... 154
 Police Kits..... 155

Rifle Kits 154
 SAF301 Universal Rod Set 157
 SAF-T-CLAD® Cleaning Rods..... 156
 Shotgun Kits 154
 Small Bore Kits 154
 TAC100 Tactical Maintenance System 155

ROGERS

64394 TAP Rack Training Aid..... 163
 64339 Ultimate Bore Squeeg-E™ Cleaning Kit 163
 66500/66501 Make Ready with Bill Rogers - DVDs..... 163
 66502 Be Fast, Be Accurate, Be the Best - Book 163

LESS LETHAL

DEFENSE TECHNOLOGY®

12-Gauge Rounds 170
 1032 CS Flameless Tri-Chamber Chemical Grenades 172
 1056 OC Vapor Grenade..... 173
 1082 Riot Control Grenade..... 172
 1083 HC Military-Style Max Smoke Grenade..... 172
 1088 Stinger® Rubber Ball Grenade - CS 178
 1089 Stinger® Rubber Ball Grenade - OC 178
 1210 12-Gauge Muzzle Bang / Launching 178
 1425 40mm Tactical Single Launcher 180
 1440 40mm Tactical 4-Shot Launcher 180
 1697T Training Fuze 177
 1820 Launcher Carry System Bag..... 181
 1821 Accessory Pouch Kit #1 Black 181
 3027 Drag Stabilized™ Round 170
 3028 Drag Stabilized™ Marking Round..... 170
 3105 TKO 12-Gauge Breaching Round..... 178
 6029WS 40mm Aerial Warning/Signaling Munitions 171
 6325 eXact iMPact™ 40mm Sponge Round..... 169
 6525 eXact iMPact™ 40mm Sponge Training Kit..... 169
 6530 40mm Reloadable Training Round..... 168
 7002 DD Body Cleaning Kit 177
 7007 Reduced Charge #25 4-Gram Reload..... 176
 7009 Deluxe Cleaning / Maintenance Kit..... 177
 8901 Distraction Device® Reload 176
 8901SC Distraction Device® Reload 176
 8902NR Low Roll™ 176
 8922 Low Roll II™ 176
 8933T Training Body 177
 150944 1000° Thermo Tube..... 179
 Aerial Warning/Signaling Munitions 171
 Aerial Warning/Signaling Munitions with Payload 171
 BIP Blunt Impact Projectile..... 168
 Colored Smoke Grenades..... 172
 Command Initiated Reload..... 169
 Direct Impact® Adjustable Inert, OC, Marking, CS 168
 Direct Impact® Inert, OC, Marking, CS 168
 Direct Impact® LE Extended Range Inert, OC, Marking, CS ... 168
 eXact iMPact™ Adjustable 40mm Direct Fire Munitions ... 169
 eXact iMPact™ 24-Shot Reloadable Training Kit..... 169
 eXact iMPact™ 40mm Direct Fire Munitions 169
 eXact iMPact™ LE 40mm Direct Fire Munitions..... 169
 Ferret Liquid 175
 Ferret Powder 175
 Flameless Expulsion Grenade..... 173
 Han-Ball™ Pyrotechnic Outdoor Chemical Grenades 172
 High Humidity Reload..... 176
 High Humidity Command Initiated..... 169
 M37/5846 Dispenser, Riot Control Agent, Mid-Size 183
 M1012/3021M 12-Gauge NL Point Control Cartridge 182
 M1013/3020M 12-Gauge NL Crowd Dispersal Cartridge.. 182
 M1029/6095M 40mm NL Crowd Dispersal Cartridge..... 182
 M1030/3105M 12-Gauge Shotgun Breaching Cartridge... 182
 MK-2, 3, 4 Aerosols 167
 MK-9 OC VAPOR .7% 167
 Muzzle Blast..... 175
 Non-Pyrotechnic Chemical Devices..... 175

OC Aerosol Fogger 173
 Personal Defense MK-6, 8 176
 Pocket Tactical..... 172
 Pyrotechnic Chemical Devices 172
 Pyrotechnic Outdoor White & Colored Smoke Grenades... 172
 Riot Control..... 172
 Rubber Ball Blast Grenade 178
 Skat Shell® 174
 Spede-Heat™ 37 / 40mm 174
 Stinger® Rubber Ball Grenade 178
 Triple-Chaser® 172
 XM104/1090M Stinger® Rubber Ball Grenade 183
 XM1091/6326M 40mm Extended Range NL Cartridge 182
 XM1116/3028M 12-Gauge NL Extended Range 182
 Warning / Signaling Munitions..... 171

MONADNOCK® / HIATT®

1121-2 Control Device 21 195
 1124-2 Control Device 24..... 195
 2010H Standard Chain Style Handcuffs..... 209
 2010HD Double Key Hole Handcuff 209
 2015H Standard Chain Style Handcuffs..... 209
 2036C/2448C Peacekeeper II Shield 206
 2036H/2448H Peacekeeper Shield..... 206
 2050H Standard Hinge Style Handcuffs..... 209
 2054H Oversized Hinge Style Handcuffs 209
 2055H Oversized Hinge Style Handcuffs 209
 2075H Standard Hinge Style Handcuffs 209
 2103H Rigid (Non-Folding) Handcuffs 210
 2105H Rigid (Non-Folding) Handcuffs 210
 2448E Capture Shield 206
 2906/2915 Persuader..... 97
 3035 Baton Holders 98
 3103-H Lightweight Steloy Chain Handcuffs 211
 3154-H Oversized Steloy Hinge Handcuffs 211
 5002 Universal Training Bag (UTB) 200
 5006 Universal Training Bag 2 (UTB2) 200
 5101 Side-Handle Training Baton..... 200
 5102 MFTB Straight Baton 200
 5103/5105 Straight Training Baton 200
 5106 Ultimate Straight Training Baton..... 200
 5107 Ultimate Side-Handle Training Baton 200
 6001 D-Jammer Firearm Cleaning Tool..... 97
 8210-0 Compact Spare Cuff™ 208
 8210-3 Spare Cuff™ 208
 8220-0 Compact Double Cuff™ 208
 8220-3 Double Cuff™ 208
 8400-1/8400-2 Carbon Fiber Handcuff Keys..... 210
 8500-0 Cuff Cutter..... 208
 8500-1 Safety Cutter 208
 8730 MOLLE Disposable Cuff Holder..... 98
 AutoLock® X3 HG Batons 186
 AutoLock® X3 Batons..... 187, 188
 AutoLock® HG (Heavy Gauge) Batons 188
 AutoLock® II Baton..... 189
 AutoLock® Batons..... 190
 AutoLock® Duty Kits..... 192
 AutoLock® Patrol Kits..... 192
 Baton Accessories 198
 Baton Caps 198
 Baton Tips, Grips and Finishes 199
 Classic Friction Lock Batons 191
 Classic Friction Lock Duty Kits 193
 Classic Friction Lock Patrol Kits 193
 CPX2500 Centurion™ Upper Body / Shoulder Protection ... 204, 205
 D4CC Delta™ Crowd Control Kit 197
 ECB100/MOLLE Vest Torso Attachment 201, 202
 EFP150 Forearm 201, 202
 ETP200 MOLLE Thigh & Groin Belt 201, 202
 FP100 Centurion™ Forearm Protectors 204
 Front Draw® Baton Holders 198

GP300 Centurion™ Groin Protector 204, 205
 Hindi Baton Cap™ 198
 HUEX100 Hydration System 201, 202
 KNP100 Centurion™ Neck Protector with KEVLAR®..... 202
 KS19 Protective Sleeves with KEVLAR® 202
 SAP ExoTech® Shoulder and Arm Protection 203
 MP Batons 197
 MX Series Expandable Straight Batons..... 196
 PLP Batons 196
 PR-24® Side-Handle Batons..... 194, 195
 Reflective Labels 205
 Rigid Batons 196, 197
 Side-Handle Baton Holder 198
 SX Series Expandable Straight Batons..... 196
 TPX200 Centurion™ Thigh/Groin Protection System..... 205
 TS70 Hard-Shell Shin Guard 201-205
 TR-1000 Non-Ballistic Riot Helmet..... 207
 Training Aids 200
 UL-1-H Ultimate Folding Style Handcuffs 210
 UL-5-H Ultimate Folding Style Handcuffs 210
 Wedge™ Baton Cap 198
 Wood Batons 197

PERFORMANCE APPAREL

MUSTANG SURVIVAL®

Brand Review 212, 213

SURVIVABILITY SYSTEMS

MED-ENG®

EOD® 10 Bomb Suit / EOD Tools..... 214
 Avenger Robot / Cooling and Blast Seats..... 216

FORENSICS

FORENSICS SOURCE™

EVI-PAQ® 219
 Identicator® 219
 Lightning Powder® 219
 NIK® 219
 Pre-Numbered Versa-Cones..... 219

ARMOR SYSTEMS

Aircraft Armor 223
 Armored Fighting Positions 223
 Boat Armor 223
 Custom Armor..... 222
 Guard Booths..... 222
 Guard Towers..... 222

TRAINING ACADEMY

Ballistic Shield Instructor 226
 Counter Ambush Tactics for Officer Survival Operator..... 226
 Crowd Management and Mobile Field Force Instructor 226
 Defensive Tactics Instructor 226
 Low-Light Building Searches Instructor..... 227
 Monadnock® Defensive Tactics System Instructor 211
 Patrol Rifle Instructor 227
 Riot Shield and Riot Baton Instructor 227
 Tactical Breaching Instructor..... 227

“DuPont™ and Nomex® are trademarks or registered trademarks of E.I. du Pont de Nemours and Company.”

WWW.SAFARILAND.COM

ARMOR | COMMUNICATIONS | DUTY GEAR | PROTECTIVE GEAR

Together, We Save Lives[®]

LESS LETHAL | FORENSICS | FIREARMS ACCESSORIES | TRAINING

THE **SAFARILAND**
GROUP

800.347.1200

OUTSIDE U.S.A. **904.741.5400**

13386 INTERNATIONAL PKWY, JACKSONVILLE, FL 32218

SAF12/18

©2018 SAFARILAND, LLC.